

2

Kindergarten

Skills 2 | Activity Book

Kindergarten

Skills 2

Activity Book

© 2026 Amplify Education, Inc. and its licensors
www.amplify.com

© 2015 The Core Knowledge Foundation and its licensors
www.coreknowledge.org

ISBN 979-8-89180-886-7

This work is licensed under a Creative Commons
Attribution-NonCommercial-ShareAlike
4.0 International License.

You are free:
to Share—to copy, distribute, and transmit the work
to Remix—to adapt the work

Under the following conditions:

Attribution—You must attribute any adaptations of the work in the following manner:

This work is based on original works of Amplify Education, Inc. (amplify.com) and the Core Knowledge Foundation (coreknowledge.org) made available under a Creative Commons Attribution-NonCommercial-ShareAlike 4.0 International License.

<https://creativecommons.org/licenses/by-nc-sa/4.0/>

Noncommercial—You may not use this work for commercial purposes. Contact help@amplify.com for questions and permissions.

Share Alike—If you alter, transform, or build upon this work, you may distribute the resulting work only under the same or similar license to this one by including the attribution language above.

Trademarks and trade names are shown in this book strictly for illustrative and educational purposes and are the property of their respective owners. References herein should not be regarded as affecting the validity of said trademarks and trade names.

Printed in the USA
01 XXX 2024

Skills 2

Activity Book

This Activity Book contains activity pages that accompany many of the lessons from the Teacher Guide for Unit 2. The activity pages are organized and numbered according to the lesson number and the order in which they are used within the lesson. For example, if there are two activity pages for Lesson 4, the first will be numbered 4.1 and the second 4.2. The activity pages in this book do not include written instructions for students because the instructions would have words that are not decodable. Teachers will explain these activity pages to the students orally, using the instructions in the Teacher Guide. The Activity Book is a student component, which means each student should have an Activity Book.

NAME: _____

DATE: _____

1.1

Activity Page

Directions: Ask students to simultaneously name and point to the pictures in each row from left to right. Students should work through the pictures in the top row, then the second row, then the third row, and then the bottom row.

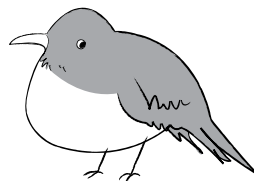
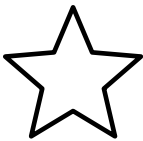
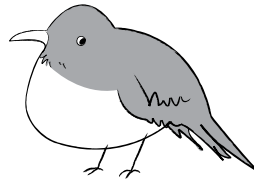
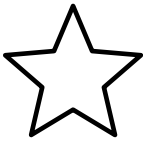
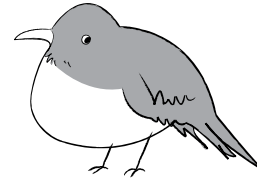
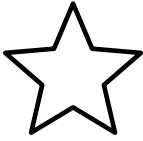
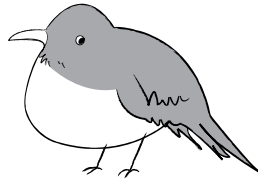
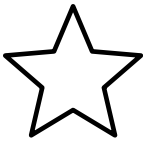

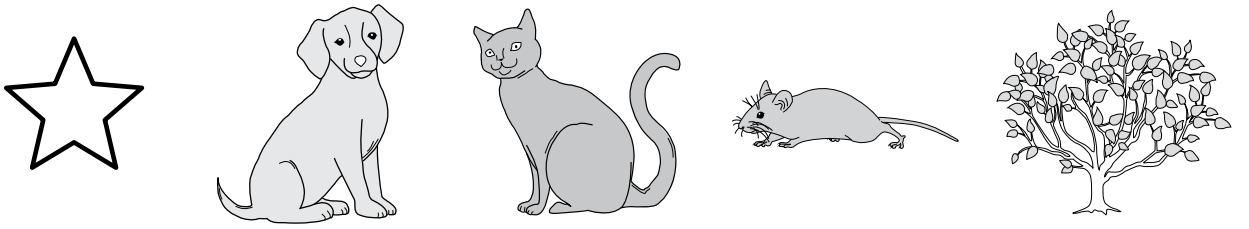

NAME: _____

DATE: _____

1.2

Directions: Ask students to trace the dotted cups, starting at the stars.





NAME: _____

DATE: _____

1.3

Take-Home

Dear Family Member,

In class, we have been practicing cup shapes. This is one of several simple shapes we are practicing for letter formation. Please have your child trace the dotted cups on the front and back of this activity page, starting at the stars. Students may color the pictures after they complete tracing (optional).

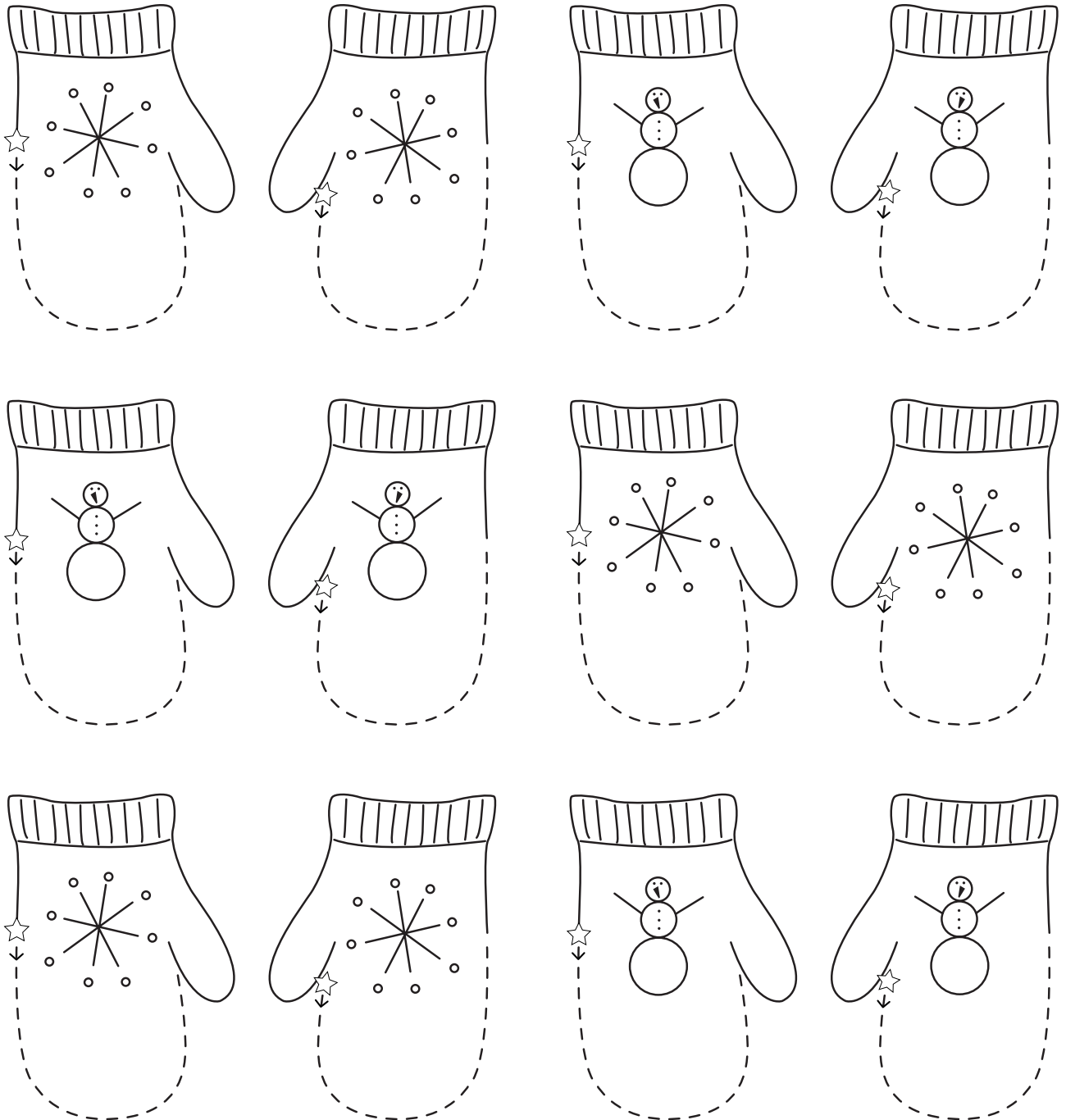

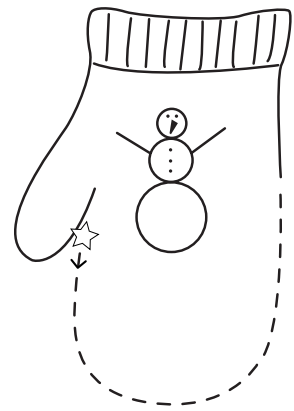
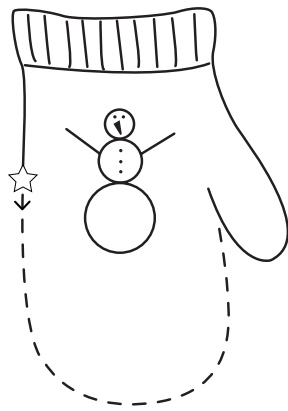
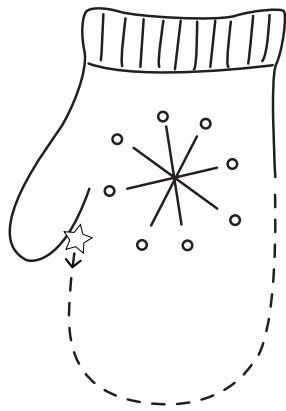
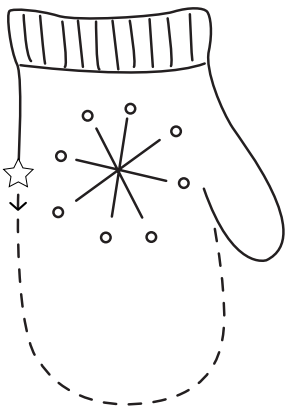
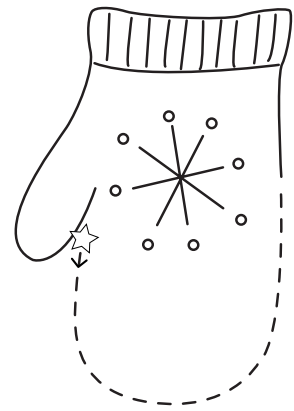
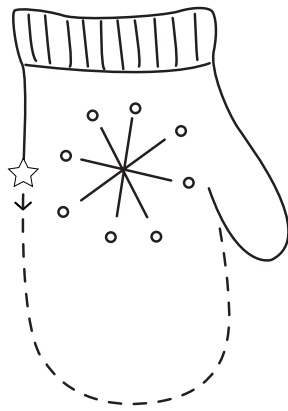
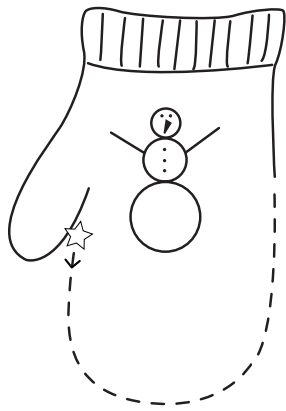
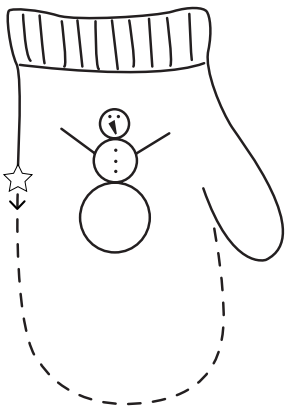
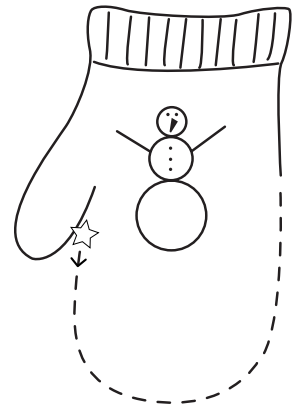
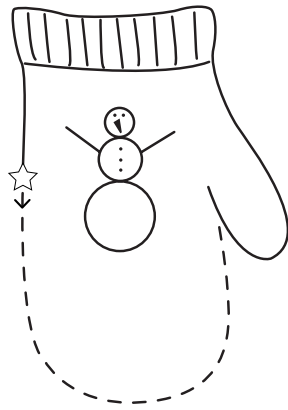
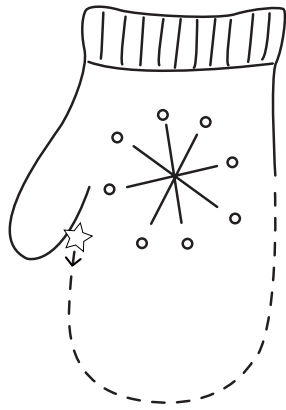
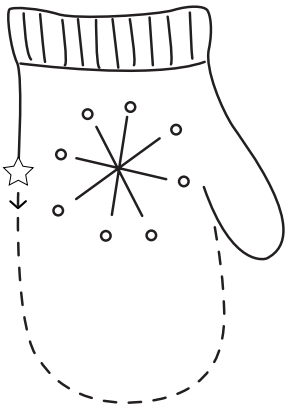
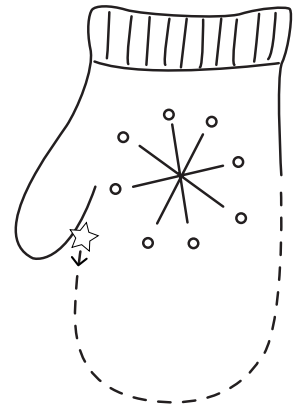
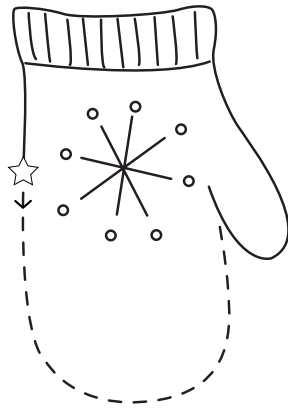
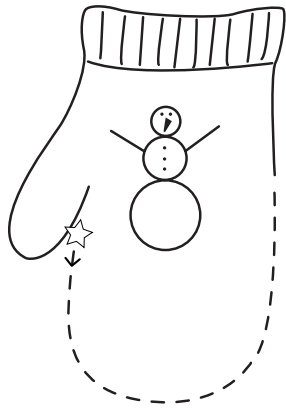
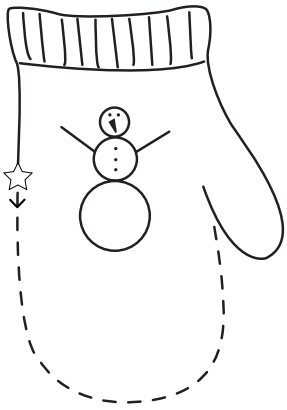

NAME: _____

DATE: _____

2.1

Activity Page

Directions: Ask students to trace the dotted humps, starting at the stars. Students may color the picture (optional).

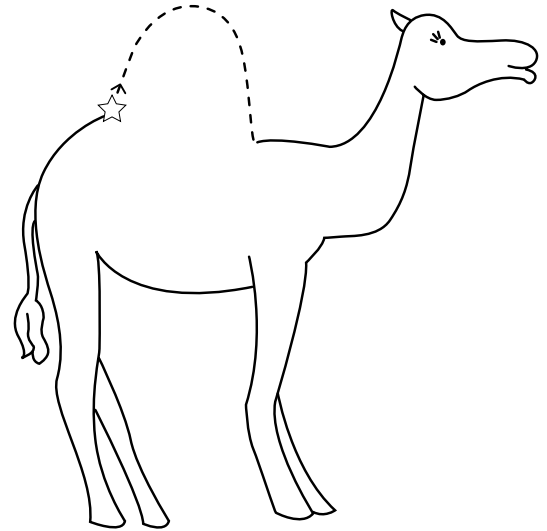
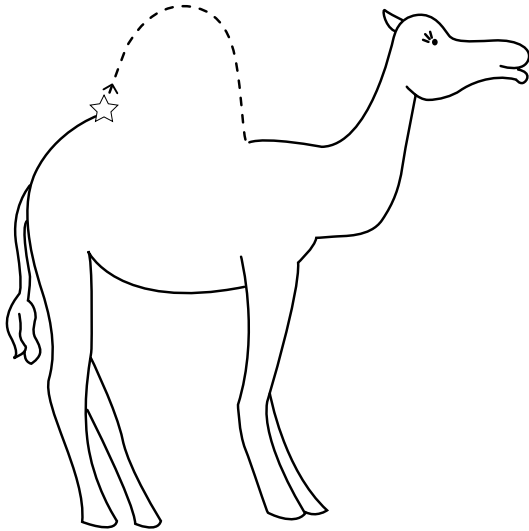
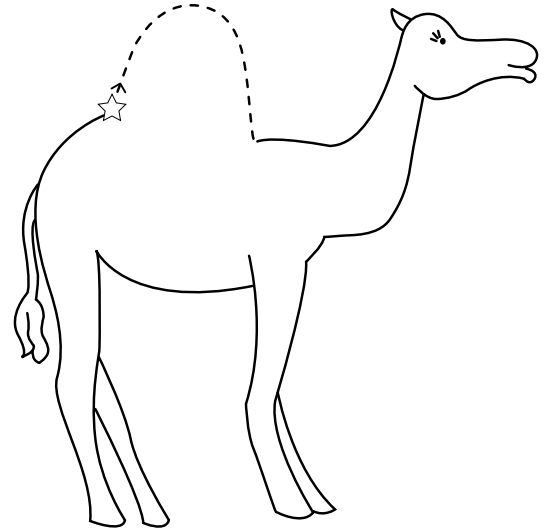
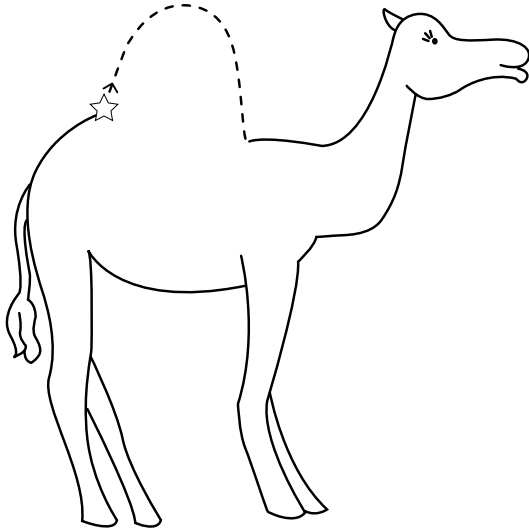
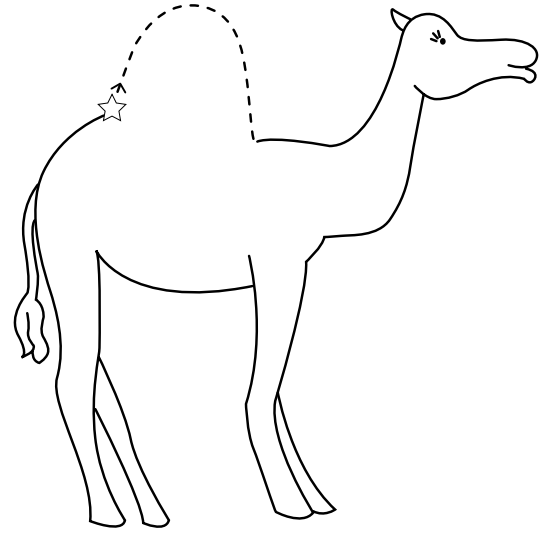
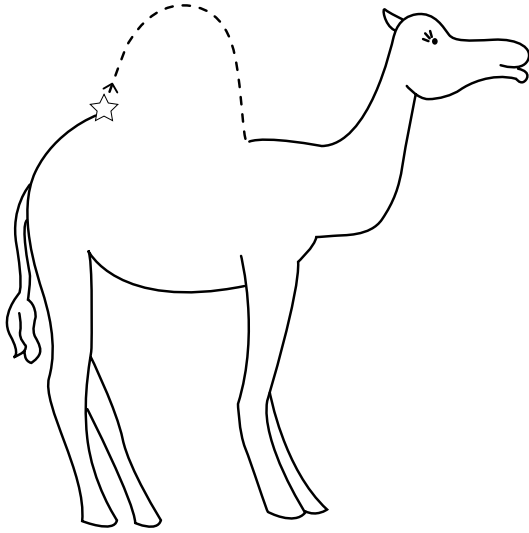

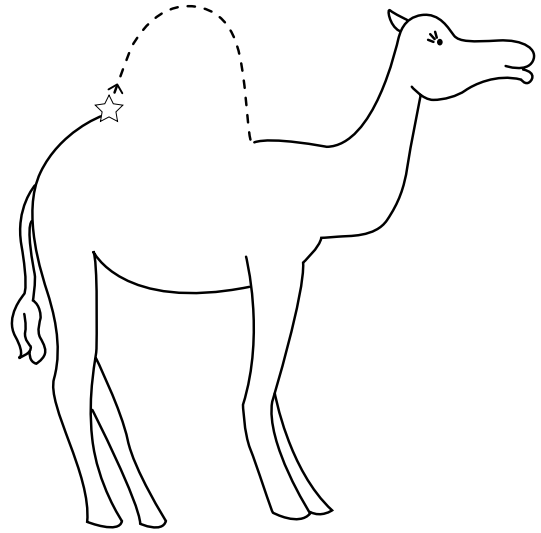
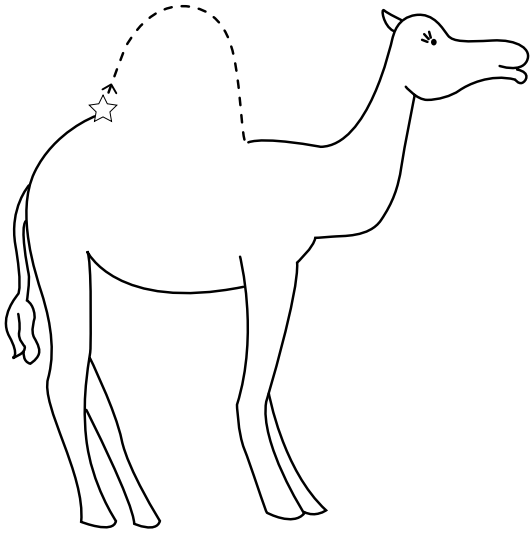
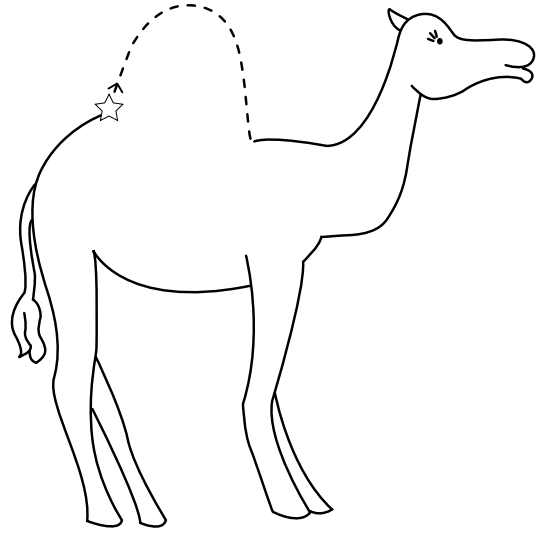
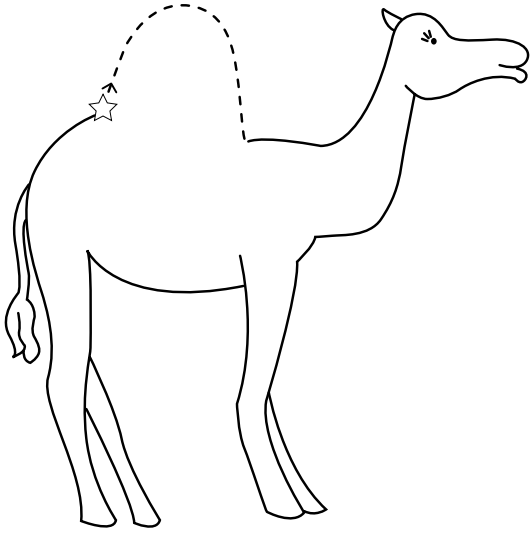
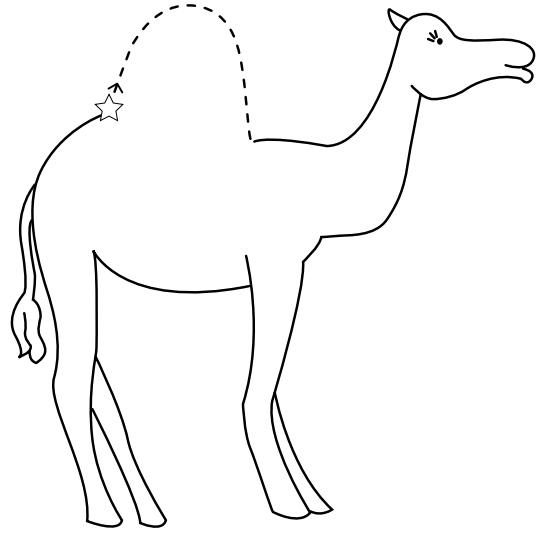
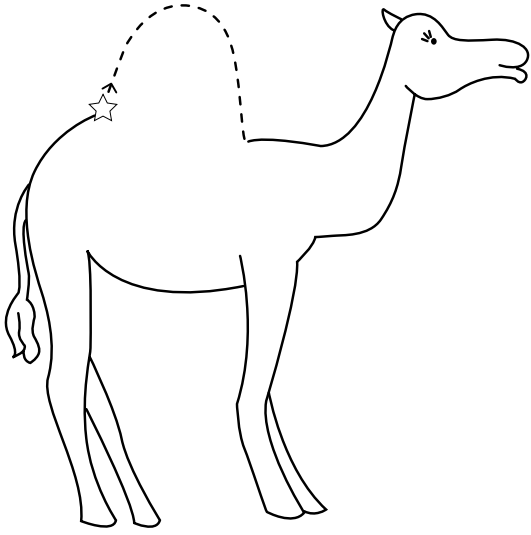

NAME: _____

DATE: _____

2.2

Take-Home

Dear Family Member,

In class, we have been practicing hump shapes. This is one of several simple shapes we are practicing for letter formation. Please have your child trace the dotted humps on the front and back of this activity page, starting at the stars.

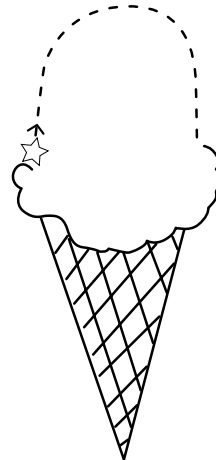
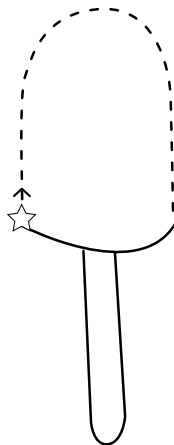
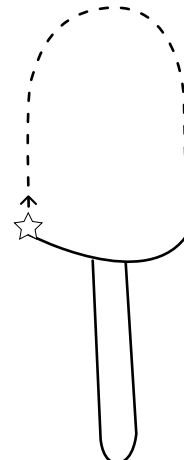
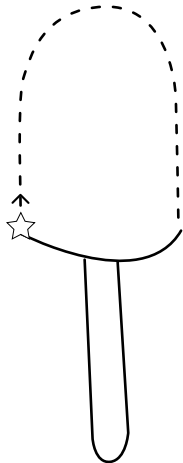
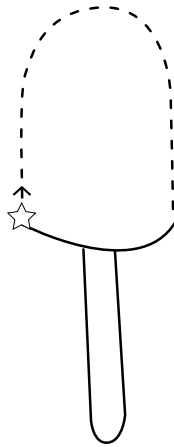

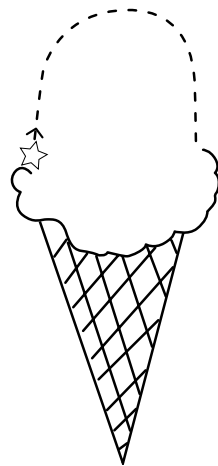
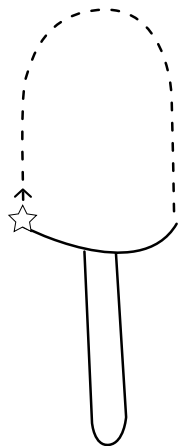
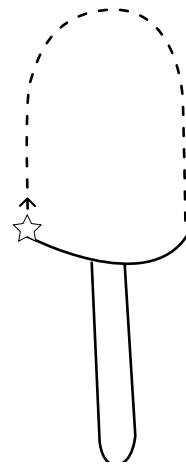
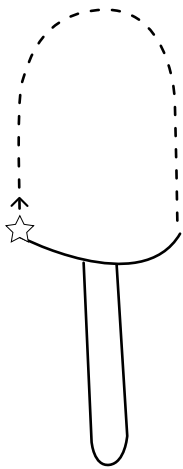
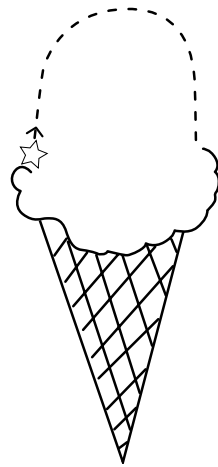
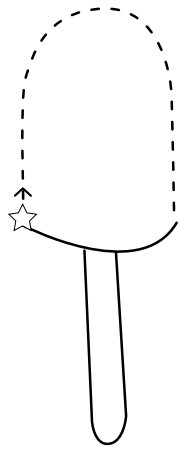

NAME: _____

DATE: _____

3.1

Activity Page

Directions: Ask students to trace the dotted zigzags, starting at the stars.

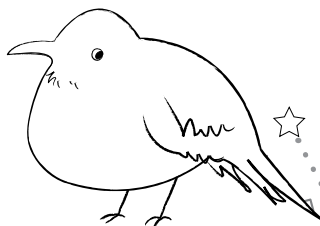
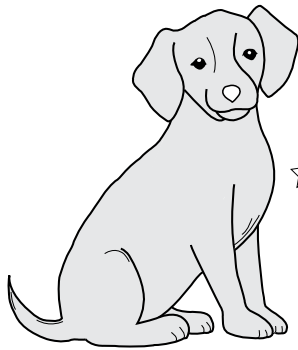
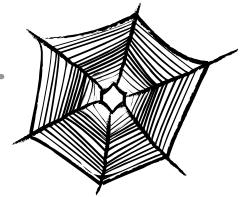
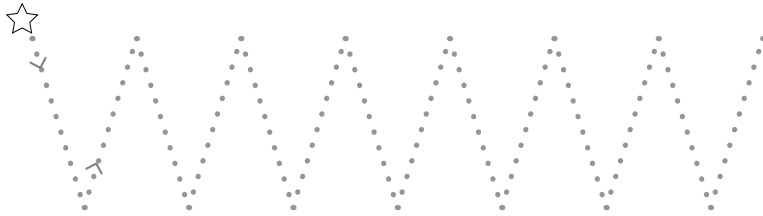
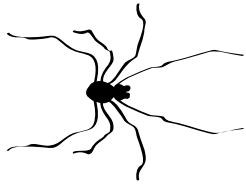
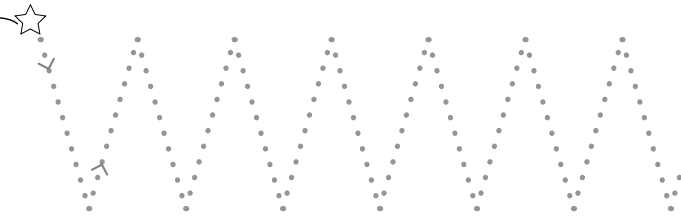
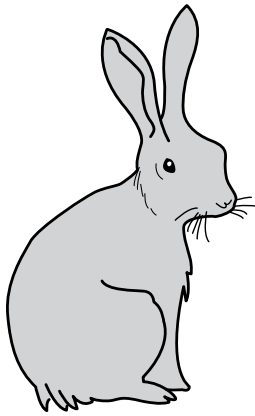

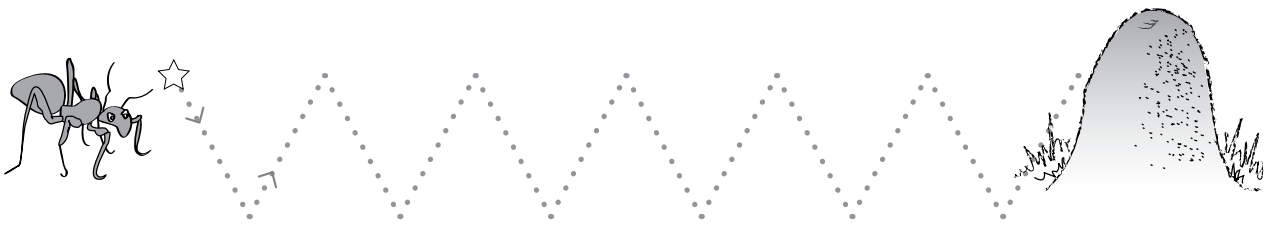





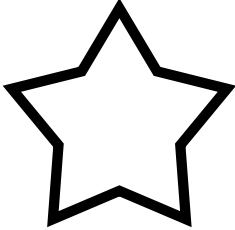
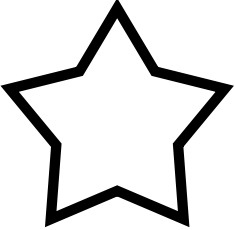
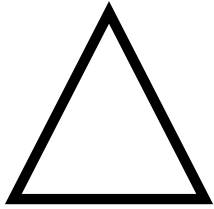

NAME: _____

DATE: _____

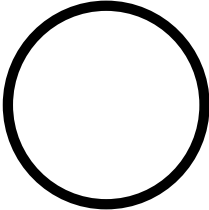
3.2

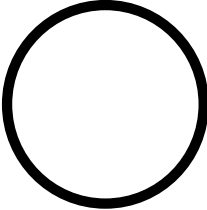
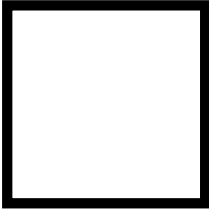
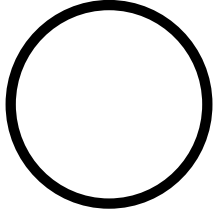
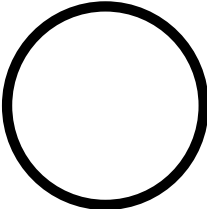
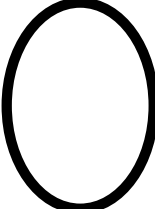
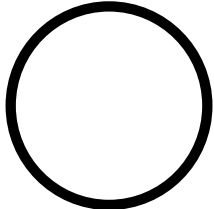
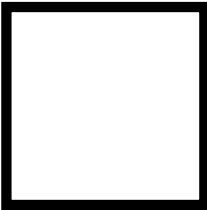
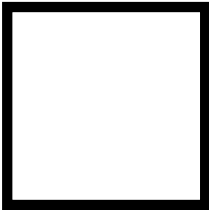
Directions: For each row, have students circle the shape that is the same as the shape on the left and cross out the shape that is different.

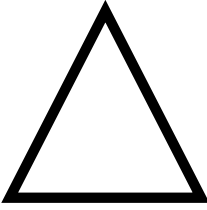
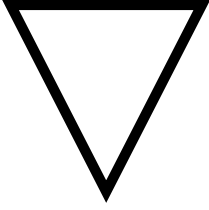
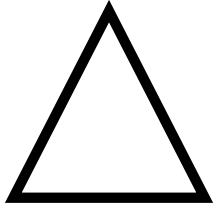
V	W	V
C	C	o
S	Z	S
T	I	T
W	M	W
F	E	F

NAME: _____











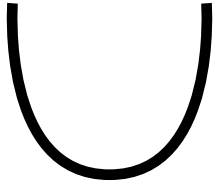

DATE: _____

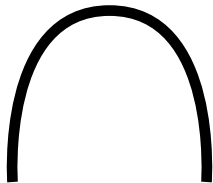
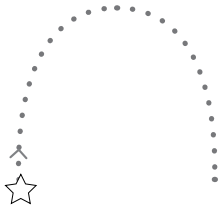
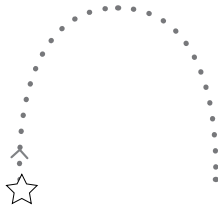
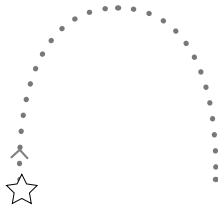













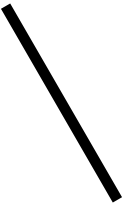



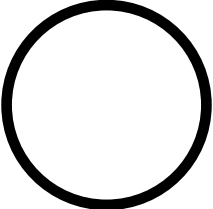

3.3

Take-Home

Dear Family Member,

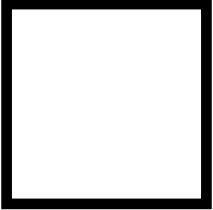
On the front and back of this activity page are a number of simple shapes we are practicing for letter formation. Please have your child trace the dotted shapes, starting at the stars.

NAME: _____

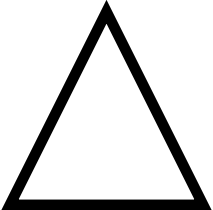
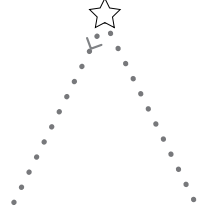
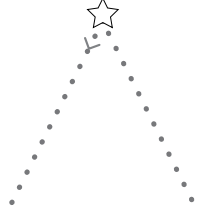
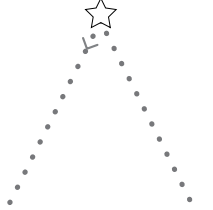
DATE: _____

4.1

Activity Page

Directions: Ask students to trace the dotted wavy lines, starting at the stars.

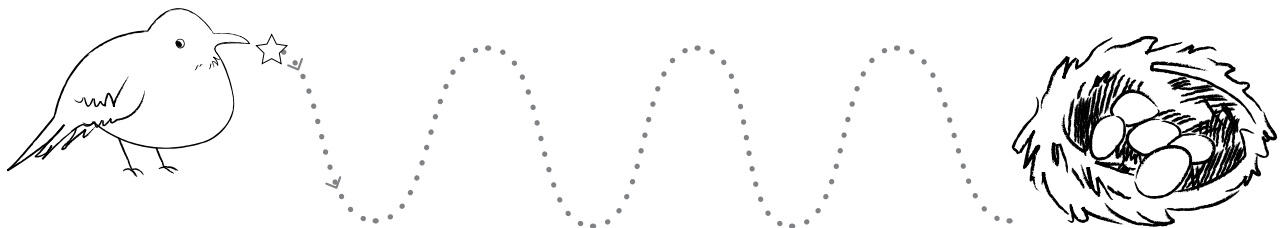
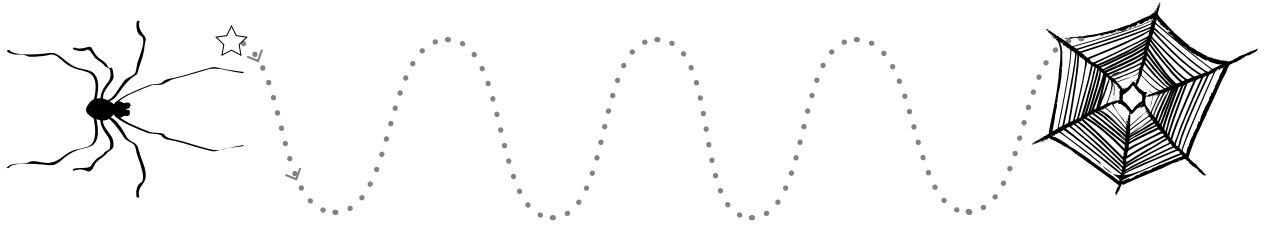
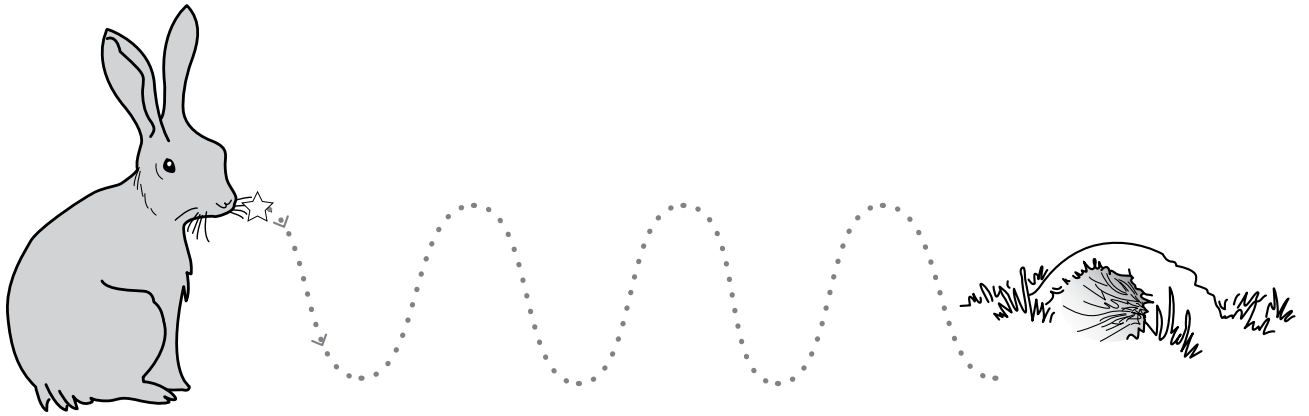

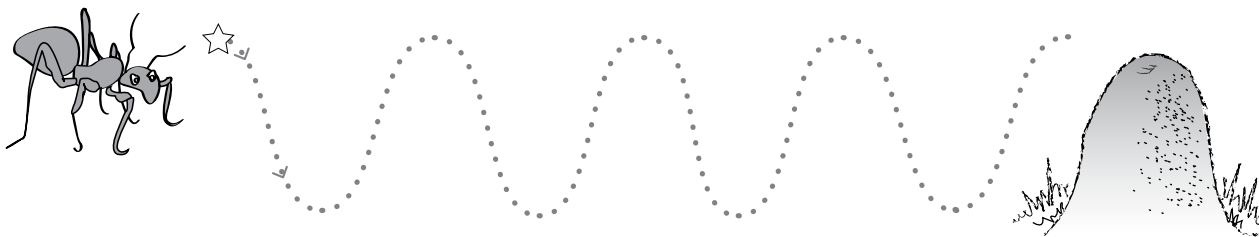
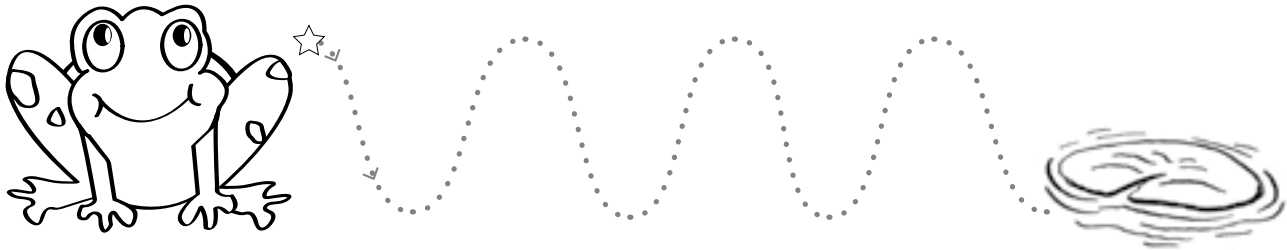
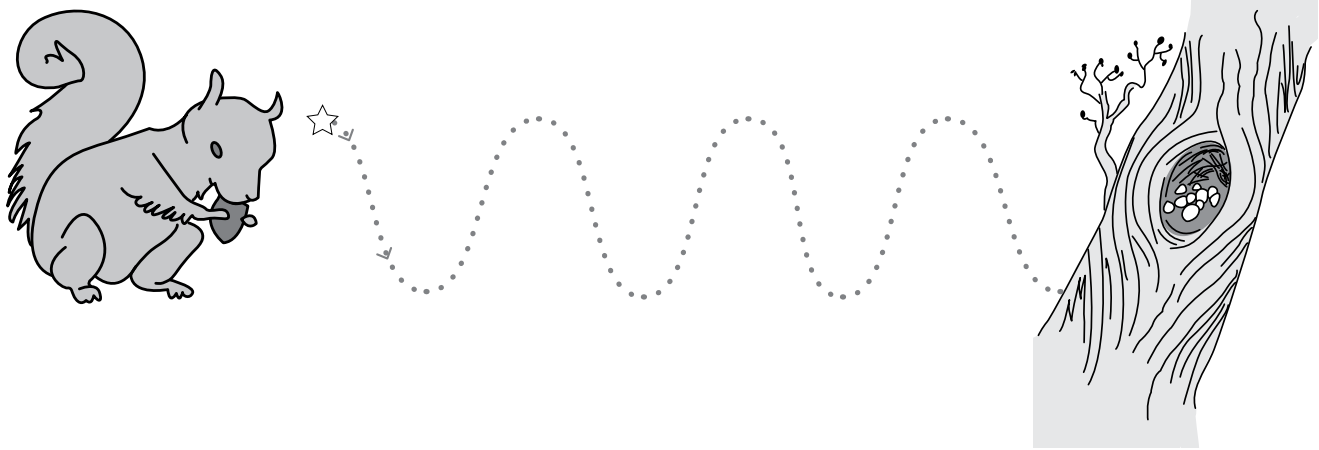
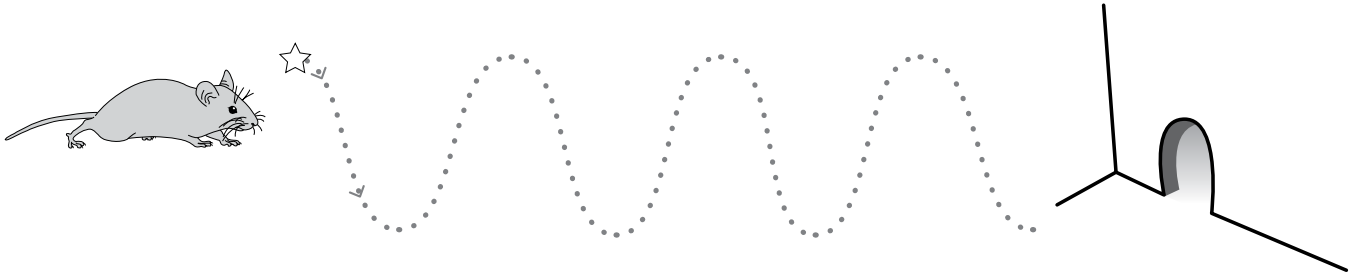

NAME: _____

DATE: _____

4.2

Activity Page

Directions: For each row, ask students to color the shape that is at the beginning green and the shape that is at the end red.

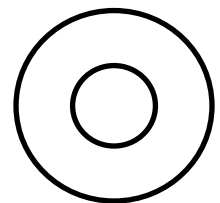
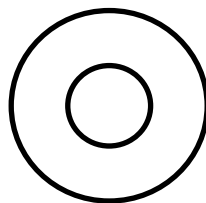
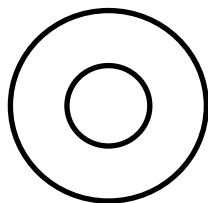
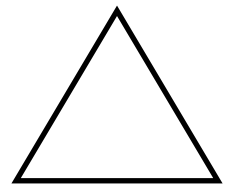
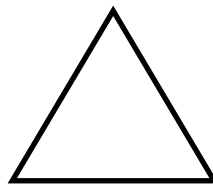
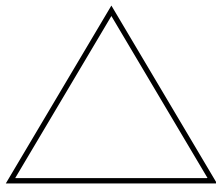
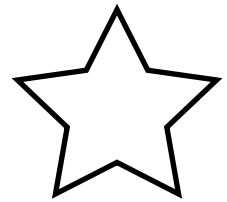
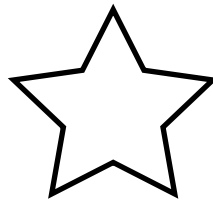
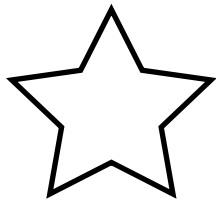
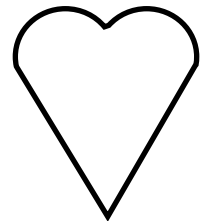
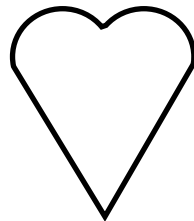
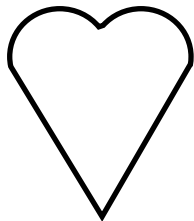
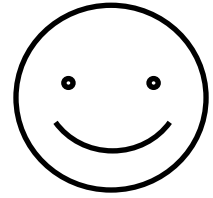
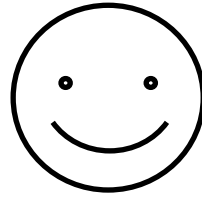
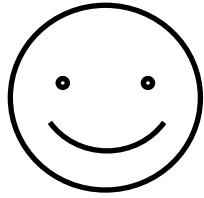

NAME: _____









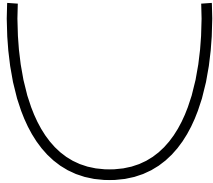

DATE: _____



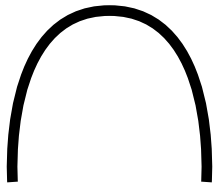
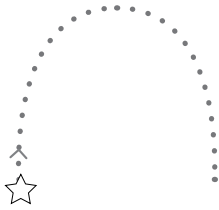
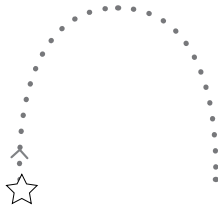
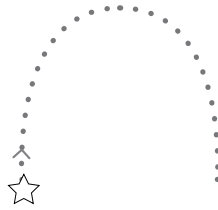



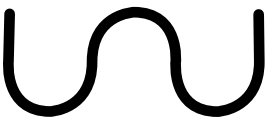







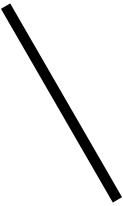



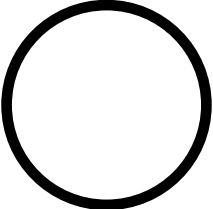

4.3

Take-Home

Dear Family Member,

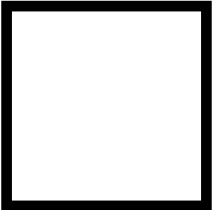
On the front and back of this activity page are a number of simple shapes we are practicing for letter formation. Please have your child trace the dotted shapes, starting at the stars.

NAME: _____

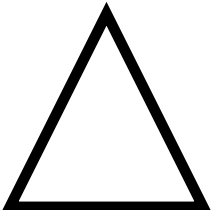
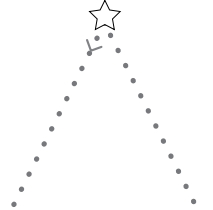
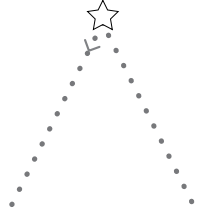
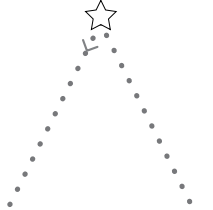
DATE: _____

5.1

Activity Page

Directions: Ask students to trace the dotted spirals, starting at the stars. Students may color the picture (optional).

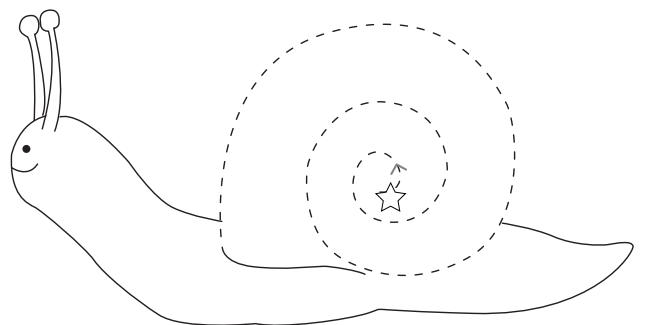
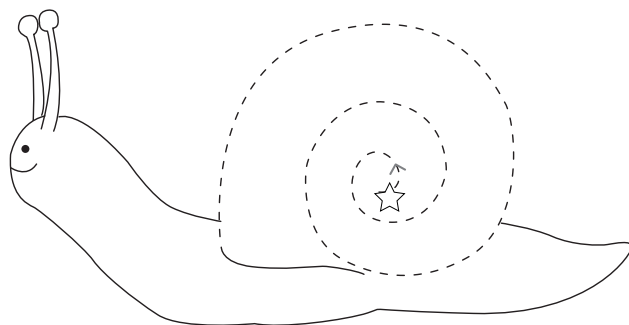
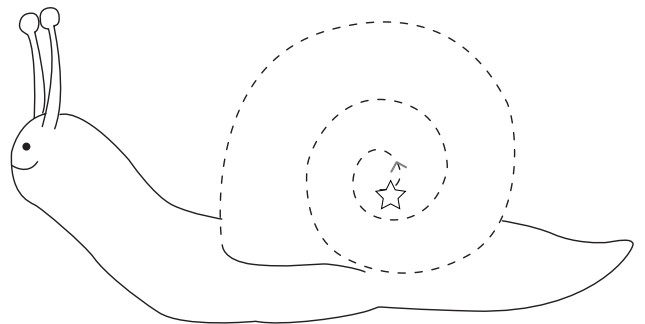
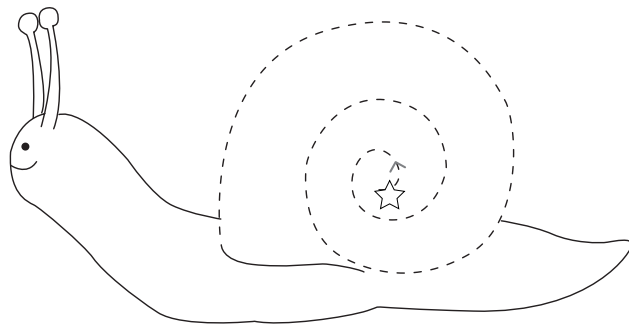
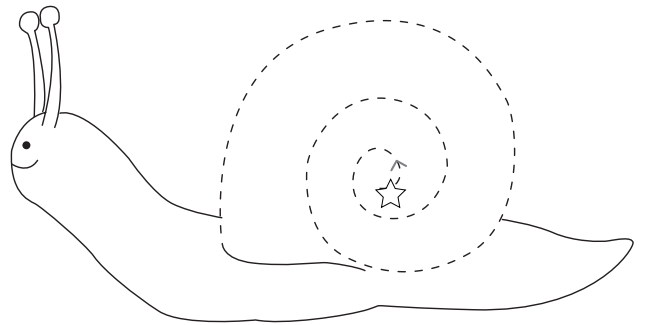
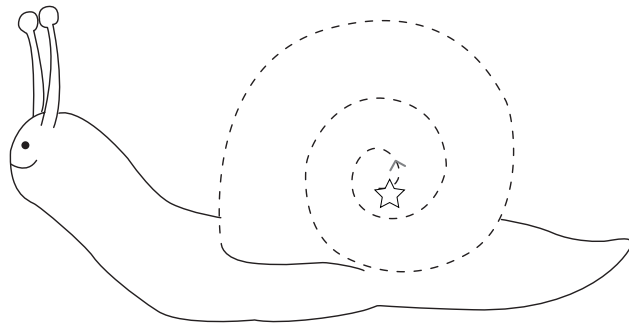
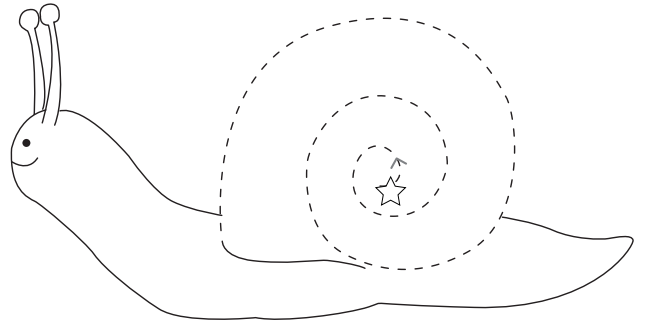
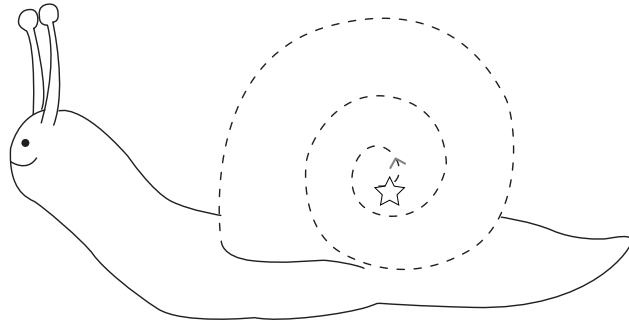

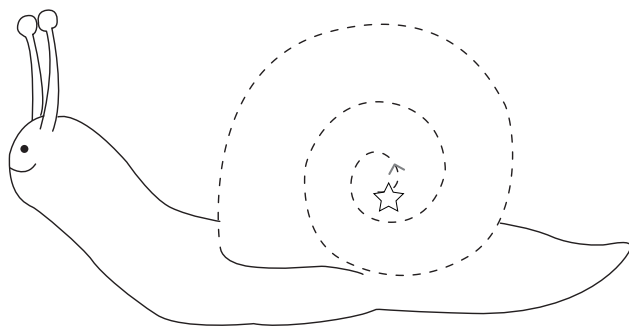
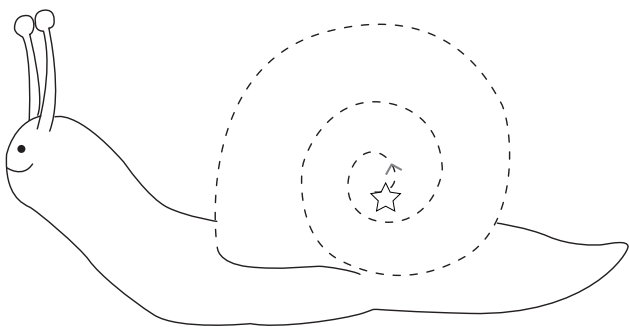
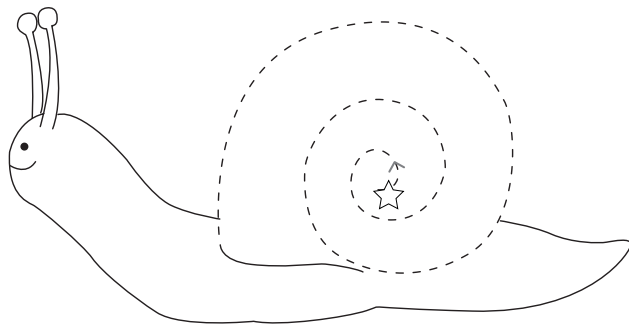
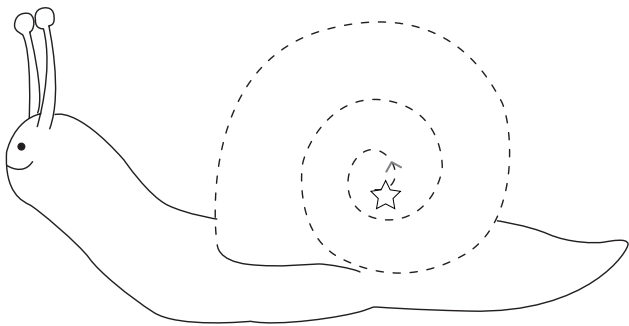
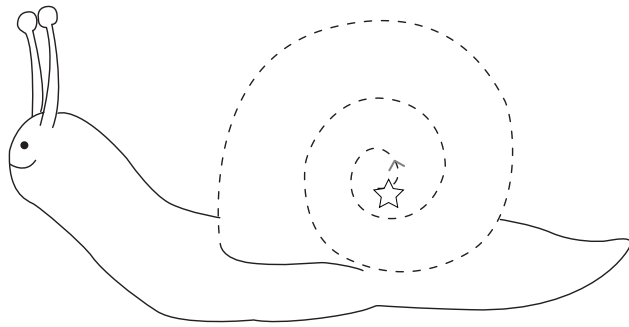
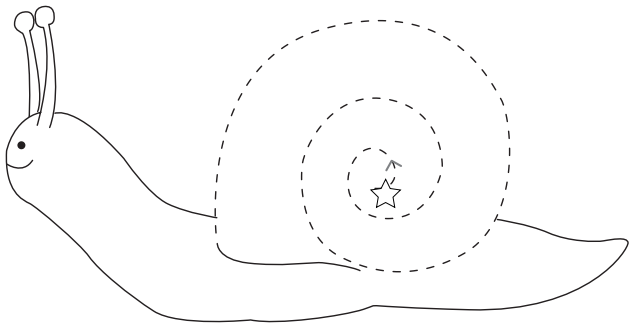
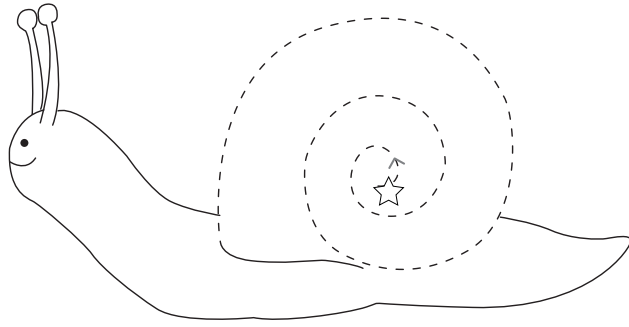
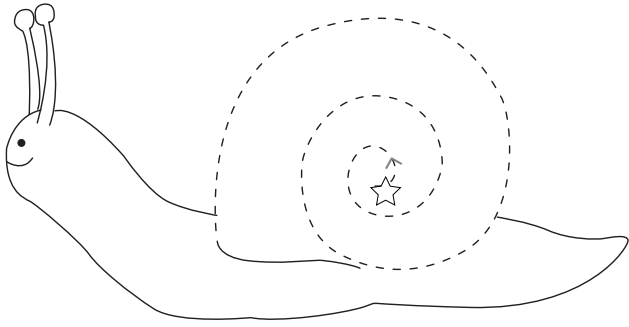

NAME: _____









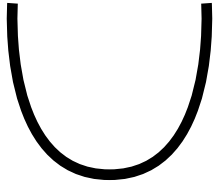

DATE: _____



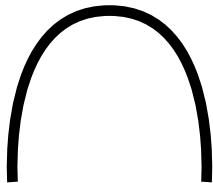
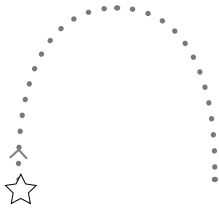
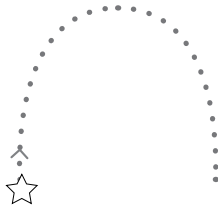
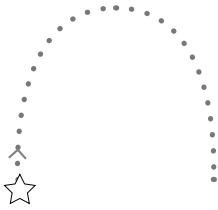







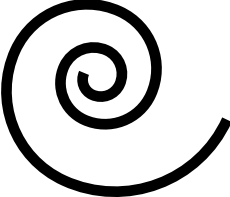
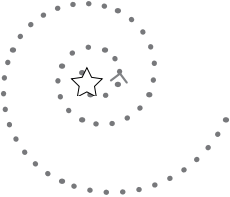
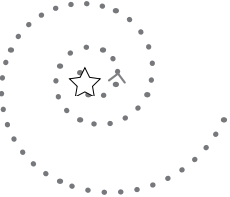





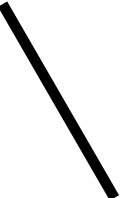

5.2

Take-Home

Dear Family Member,

On the front and back of this activity page are a number of simple shapes we are practicing for letter formation. Please have your child trace the dotted shapes, starting at the stars.

NAME: _____

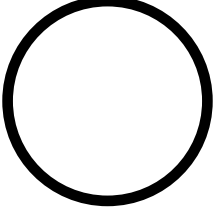
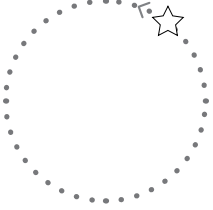
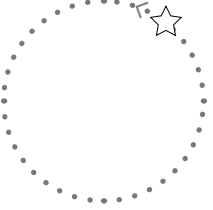
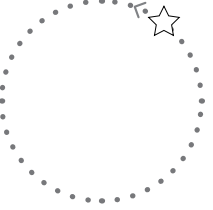
DATE: _____

6.1

Activity Page

Directions: Ask students to trace the dotted shapes, starting each line at a star.

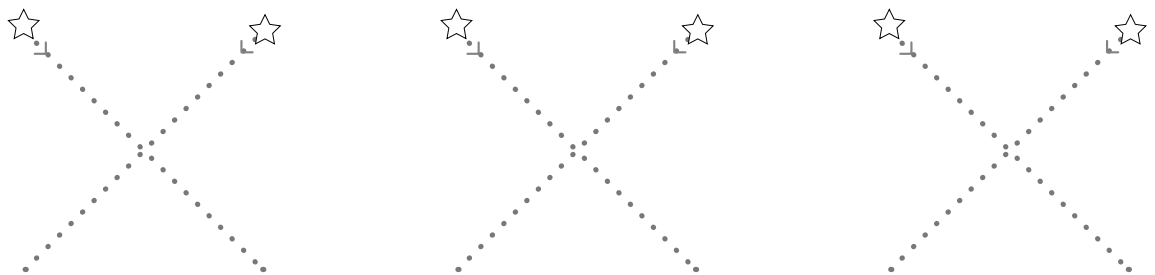
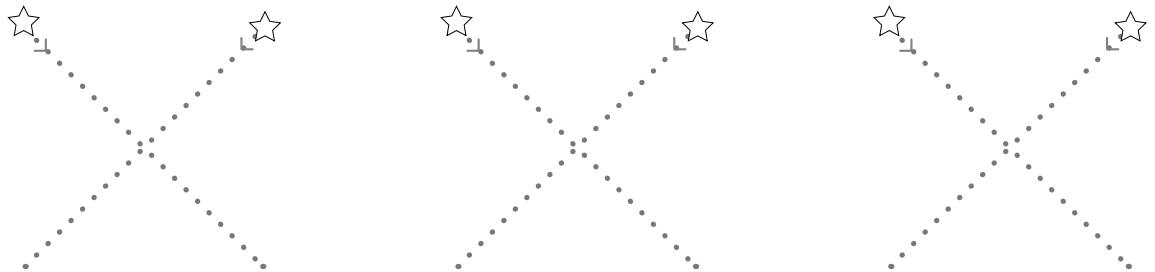
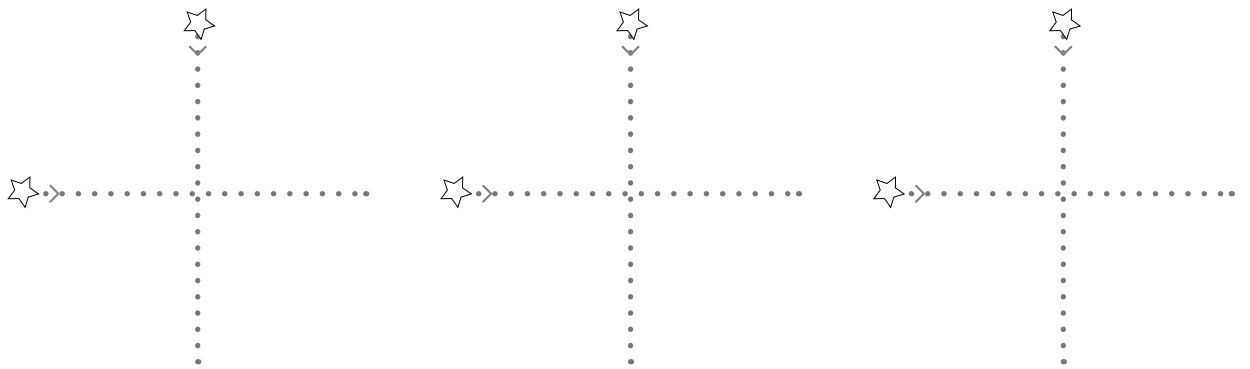
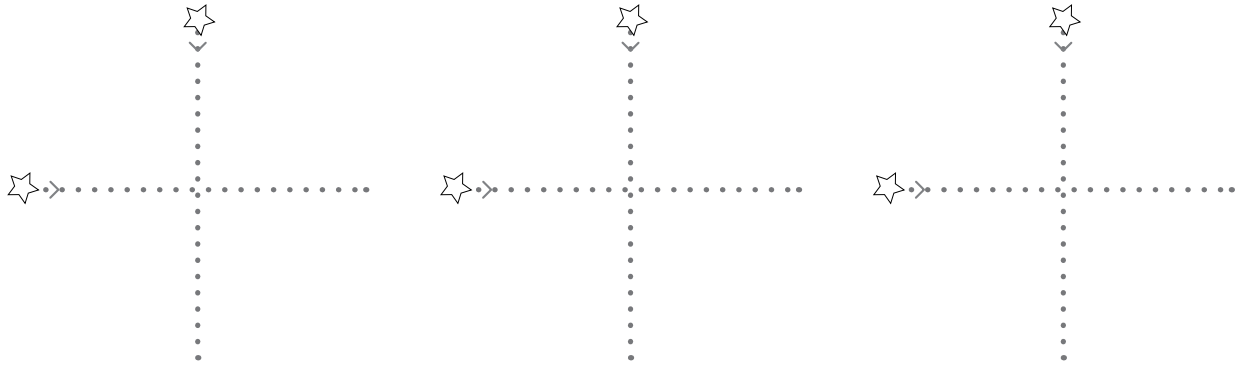

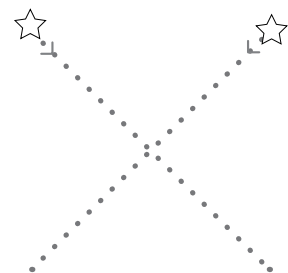
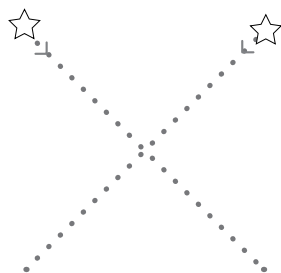
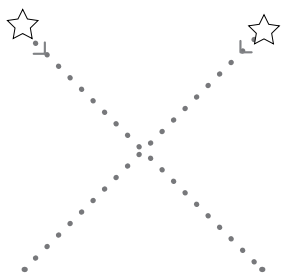
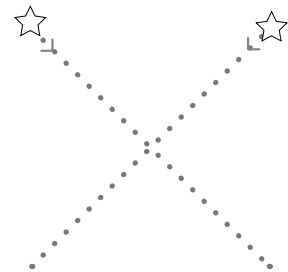
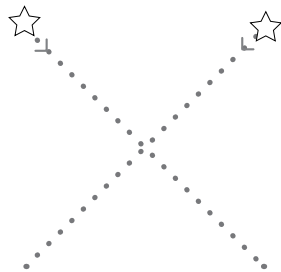
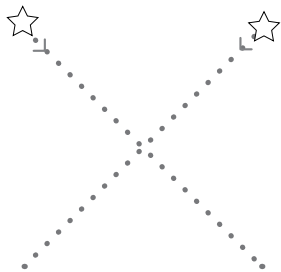
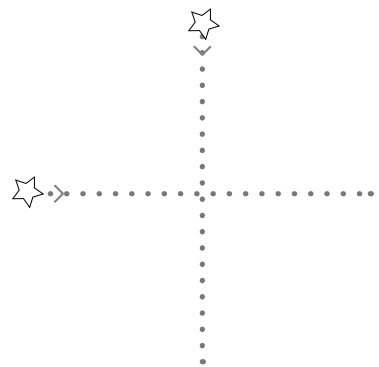
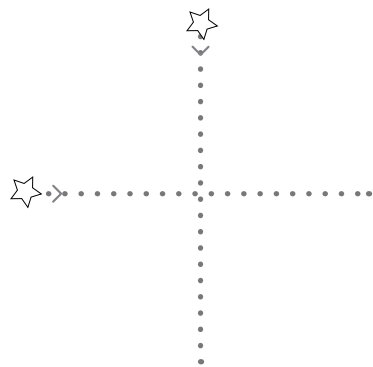
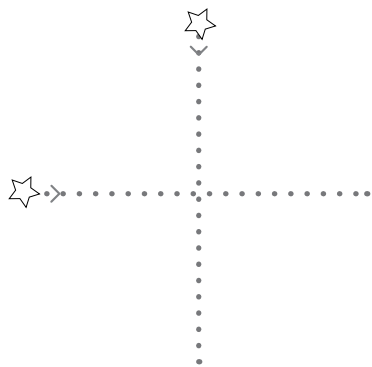
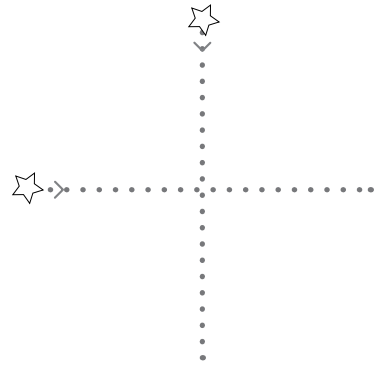
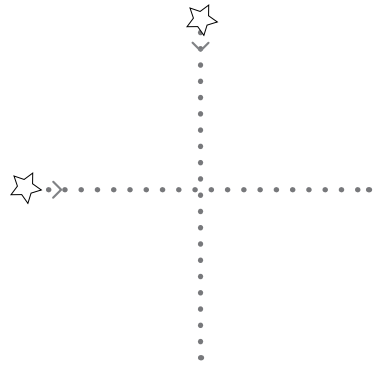
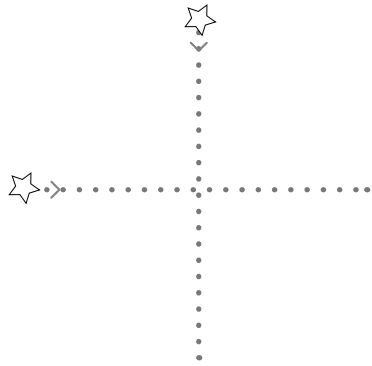

NAME: _____

DATE: _____

6.2

Take-Home

Dear Family Member,

In class, we have been practicing **+**'s and **X**'s. These are some of several simple shapes we are practicing for letter formation. Please have your child trace the dotted **+**'s and **X**'s on the front and back of this activity page, starting each line at a star.

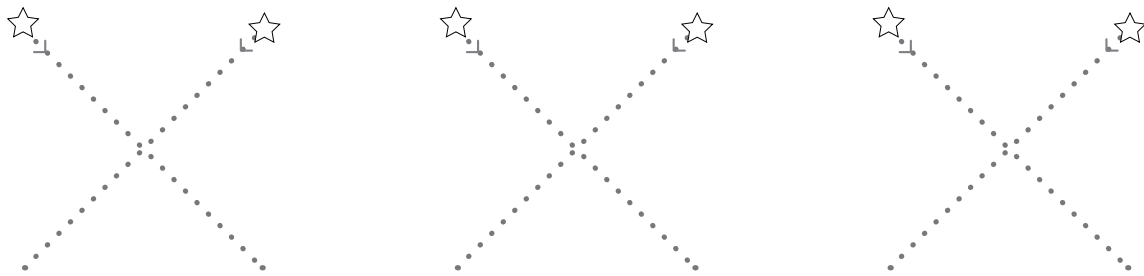
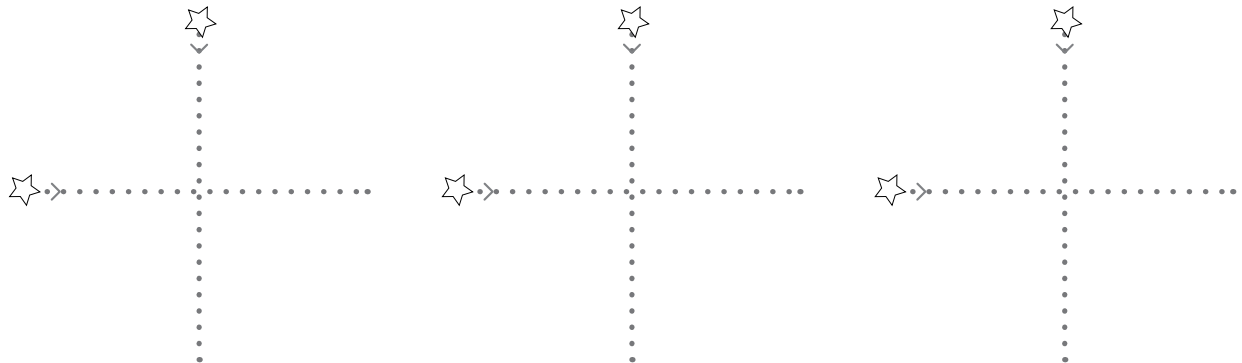
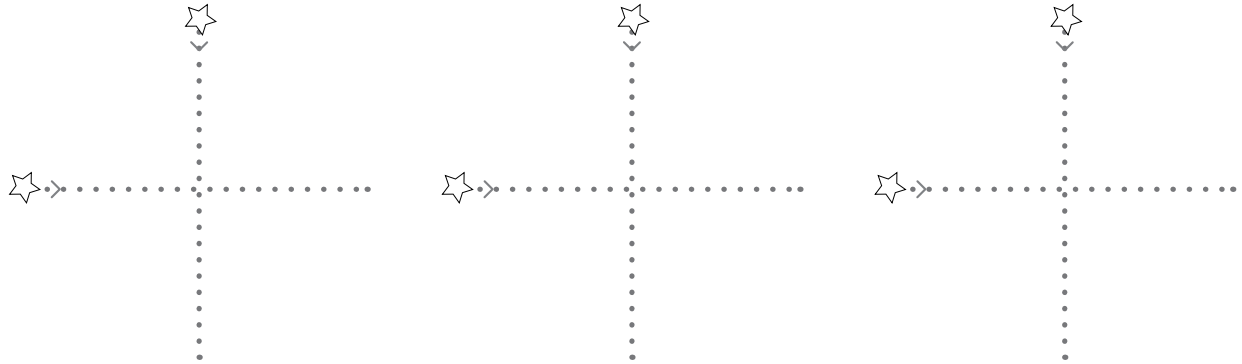

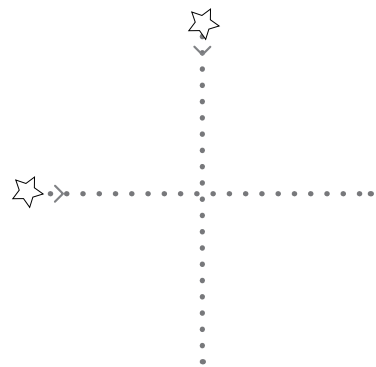
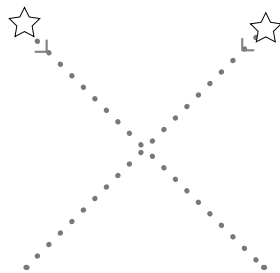
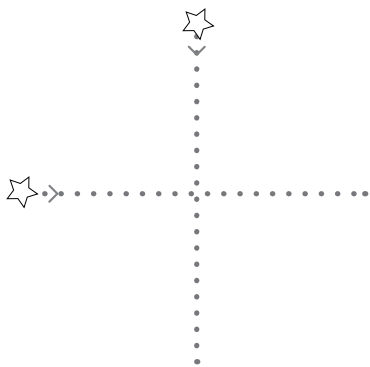
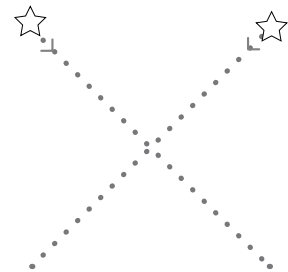
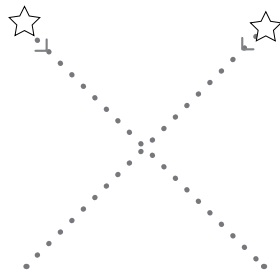
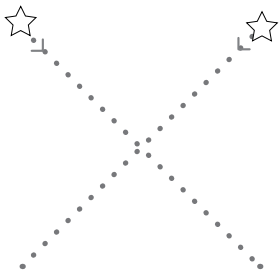
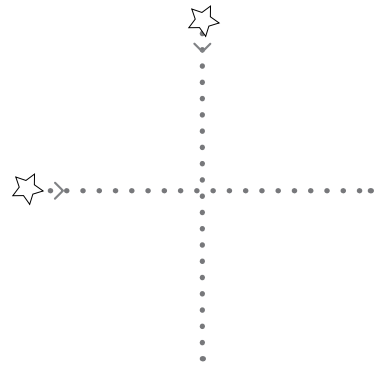
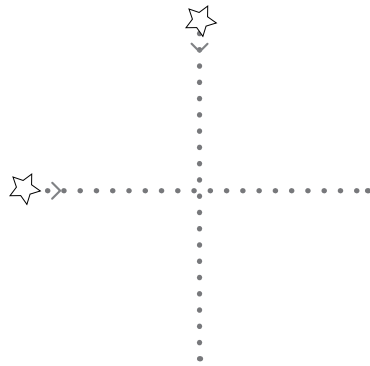
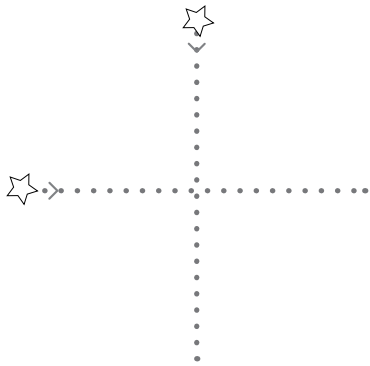
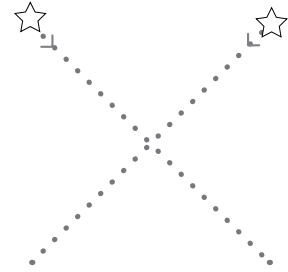
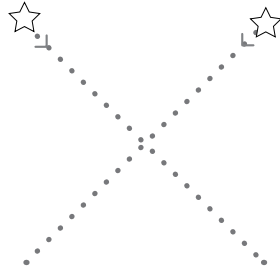
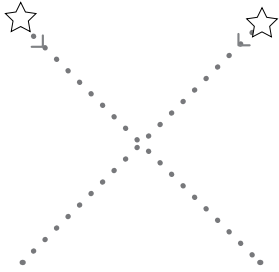

NAME: _____

DATE: _____

7.1

Directions: Ask students to trace the dotted loops, starting at the stars. Students may color the pictures (optional).

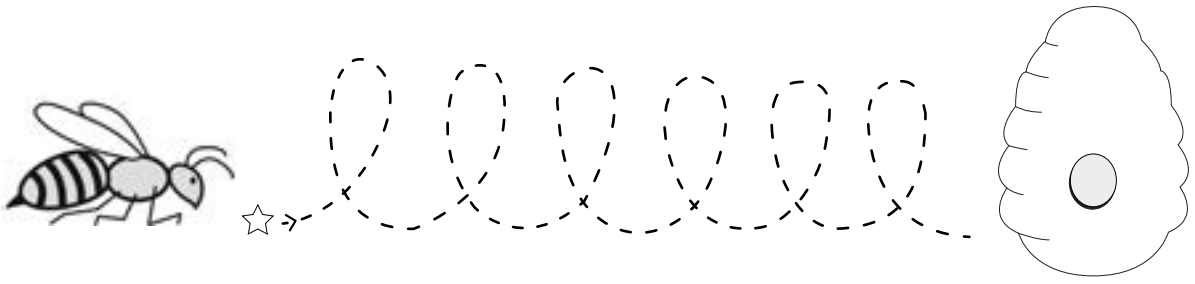
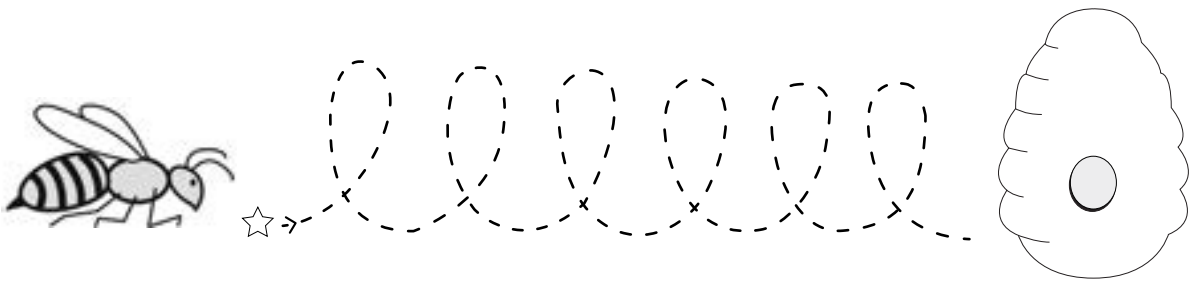
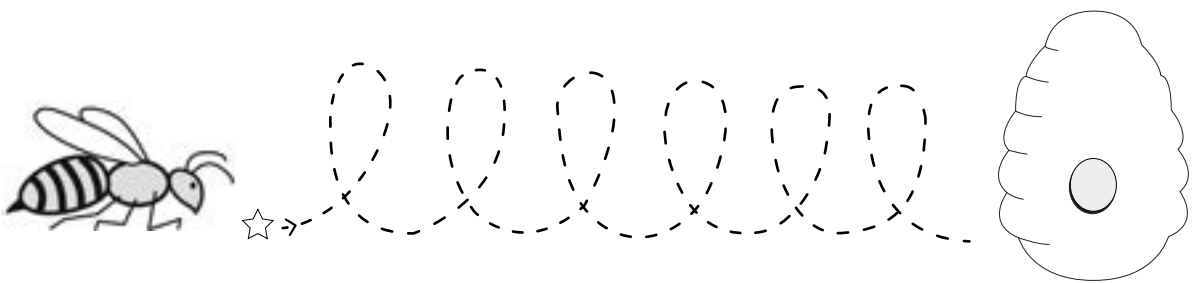
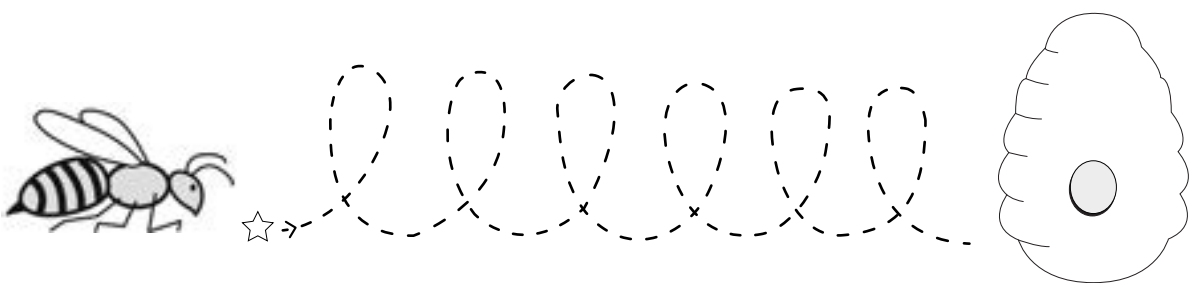
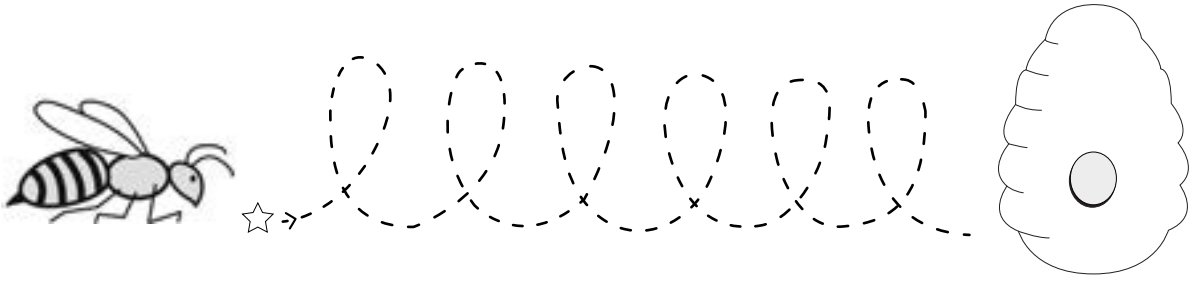

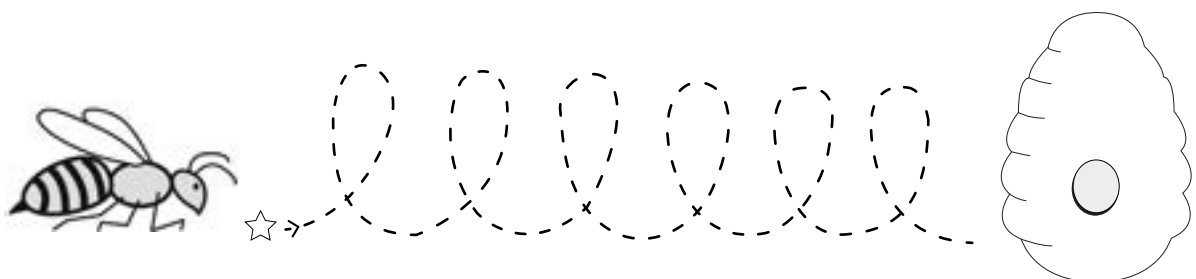
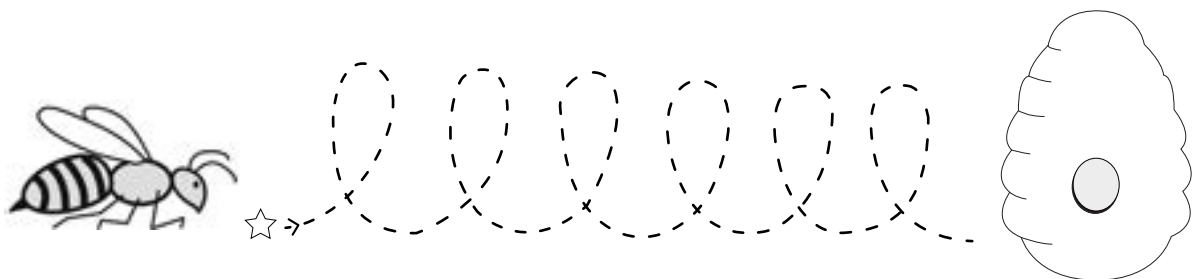
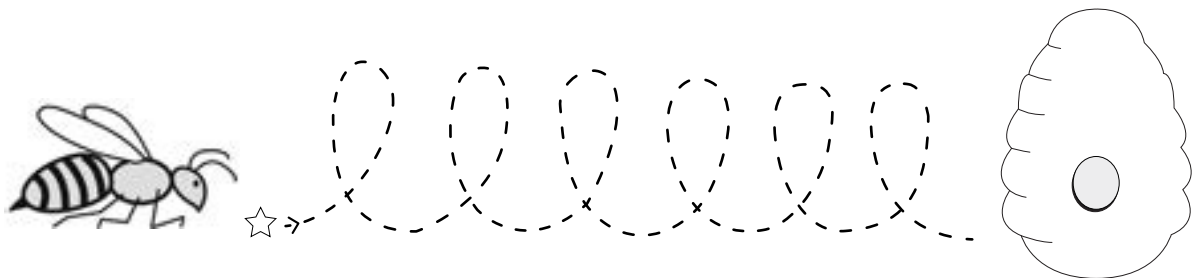
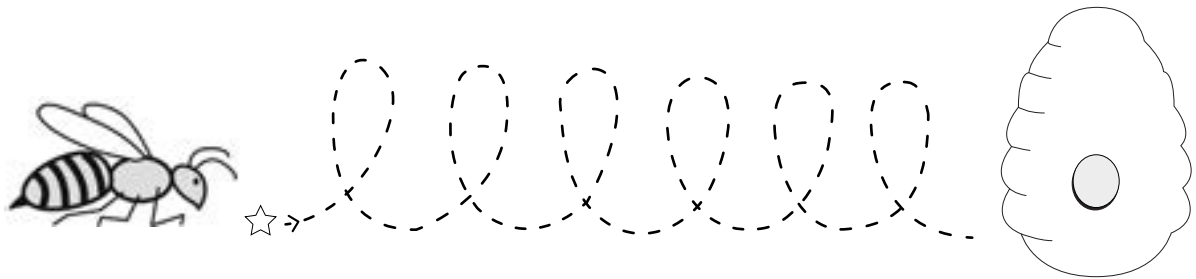
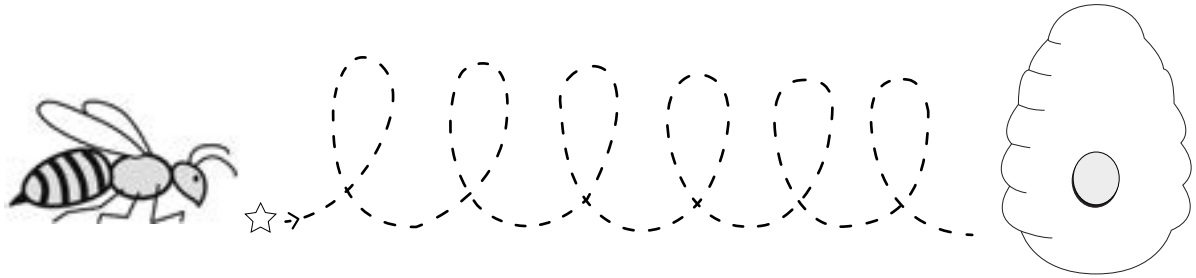

NAME: _____











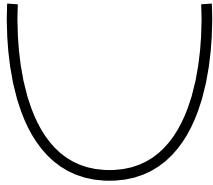
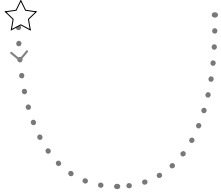

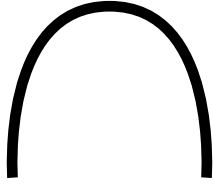
DATE: _____









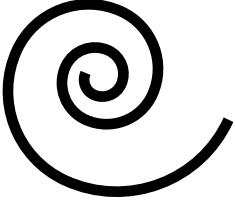
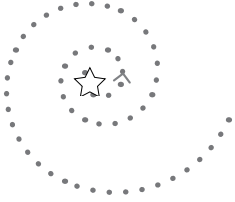

7.2

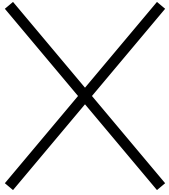
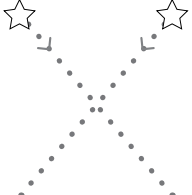
Take-Home

Dear Family Member,

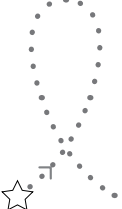
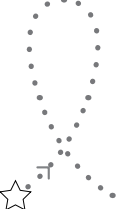
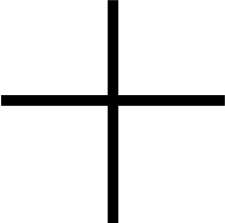
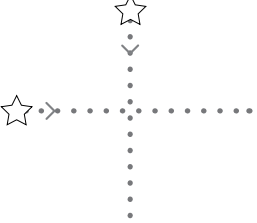
On the front and back of this activity page are a number of simple shapes we are practicing for letter formation. Please have your child trace the dotted shapes, starting at the stars. Then have them draw the shape on their own, starting at the star.

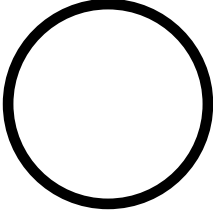
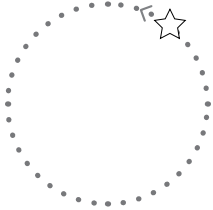
NAME: _____

DATE: _____

8.1

Activity Page

Directions: Ask students to trace the dotted canes, starting at the stars. Students may color the pictures (optional).

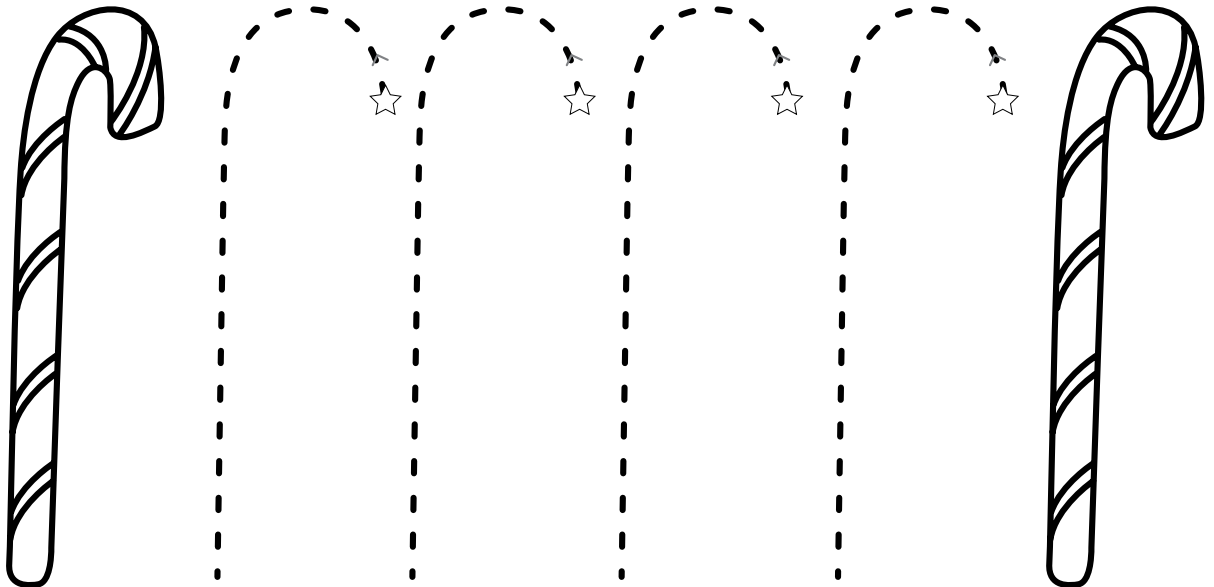
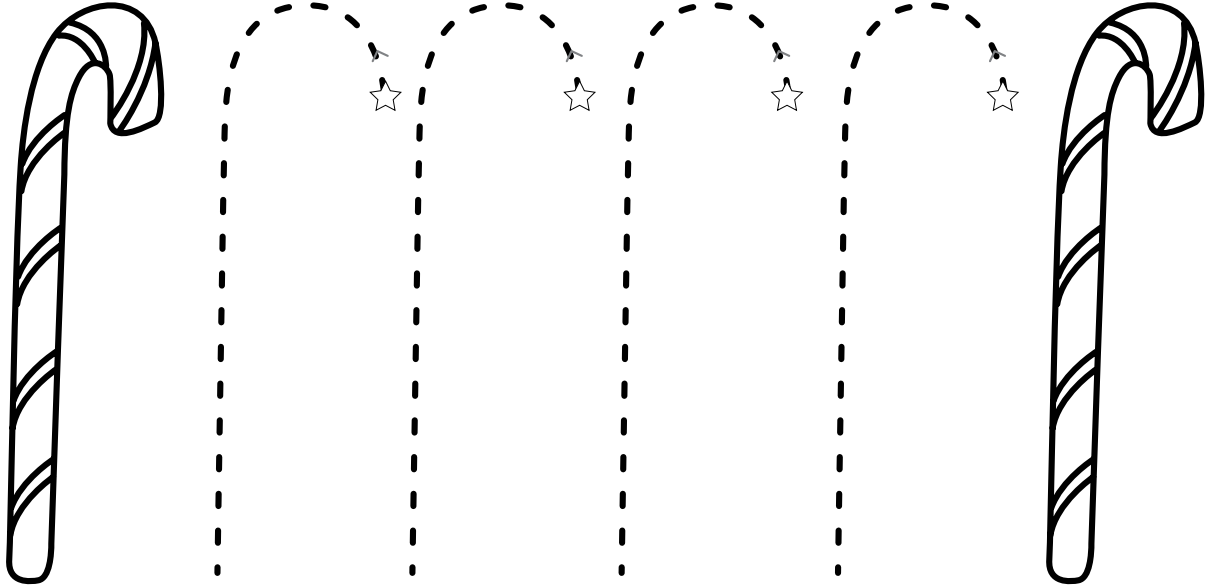

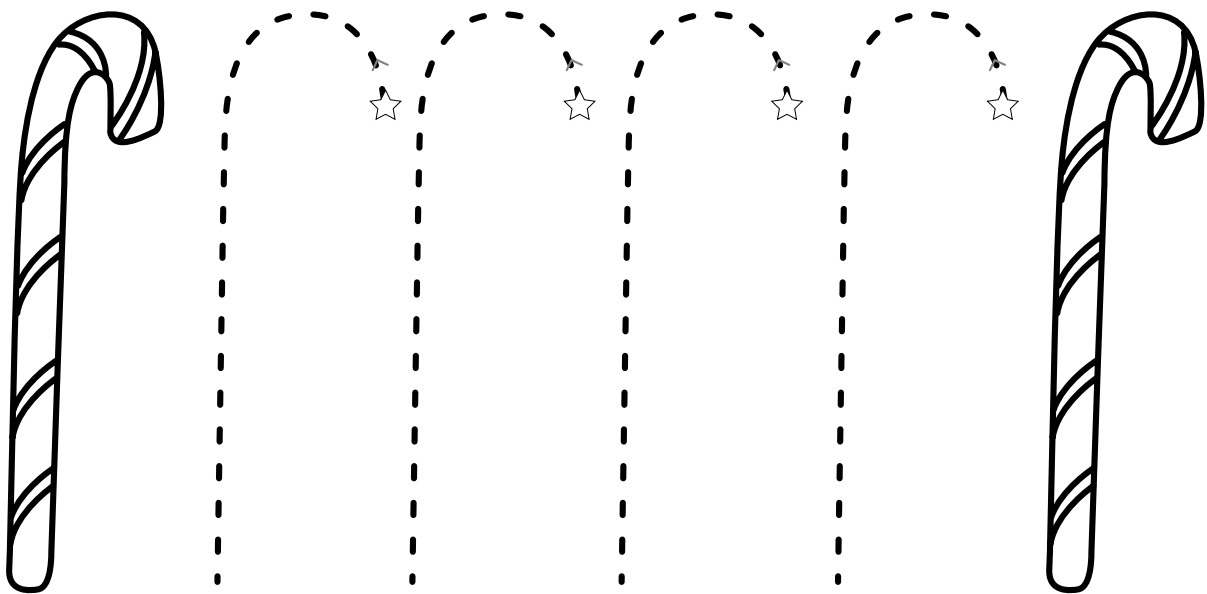
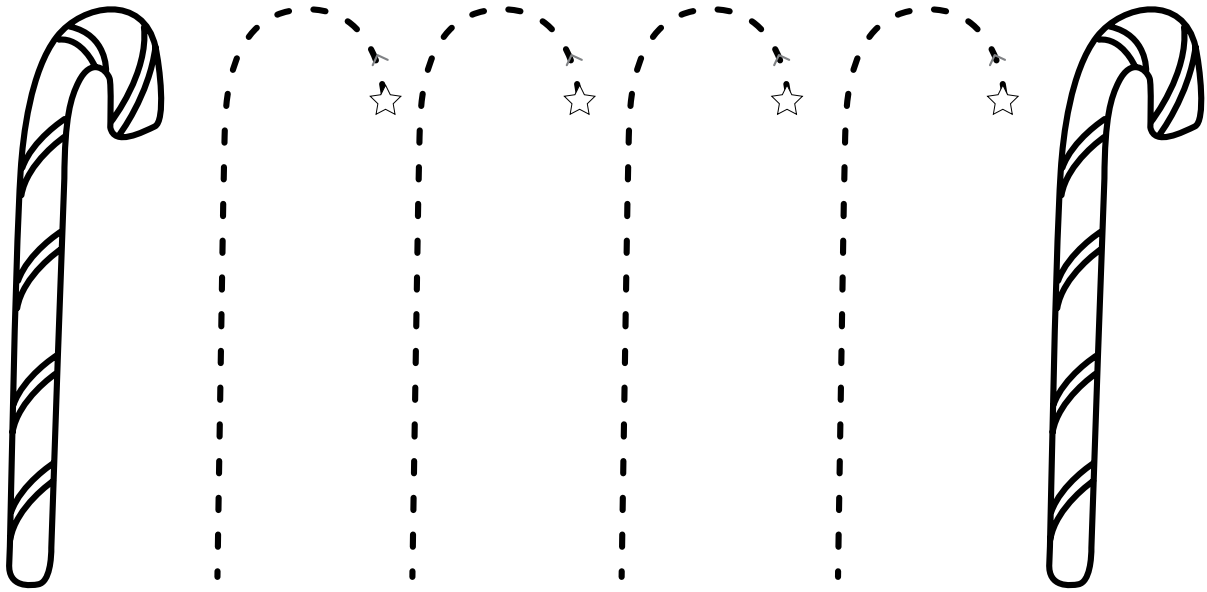

NAME: _____

DATE: _____

8.2

Take-Home

Dear Family Member,

In class, we have been practicing the cane shape. This is one of several simple shapes we are practicing for letter formation. Please have your child trace the dotted canes on the front and back of this activity page, starting at the stars.

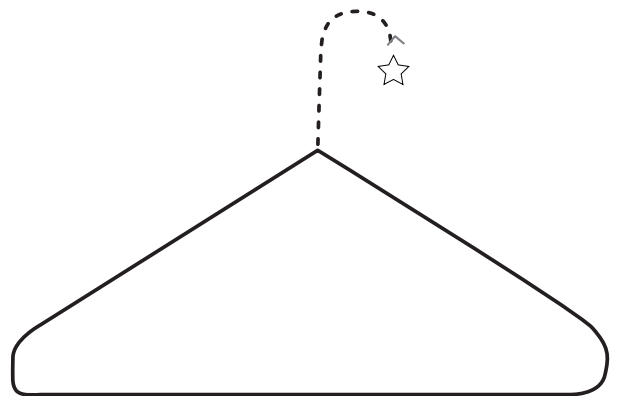
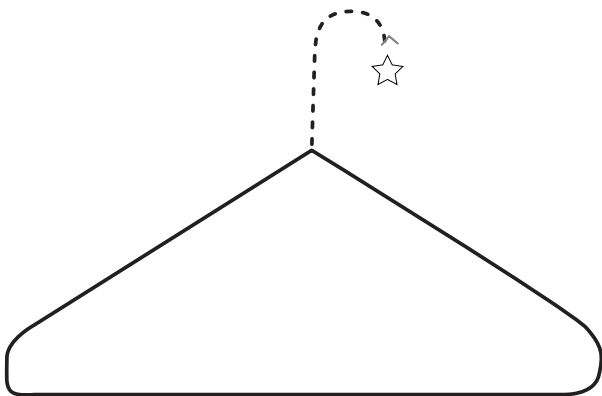
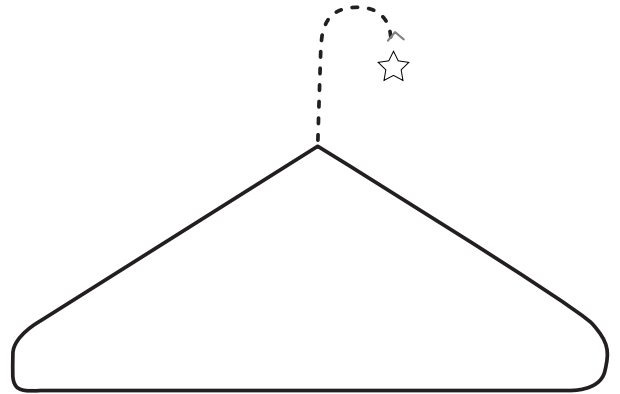
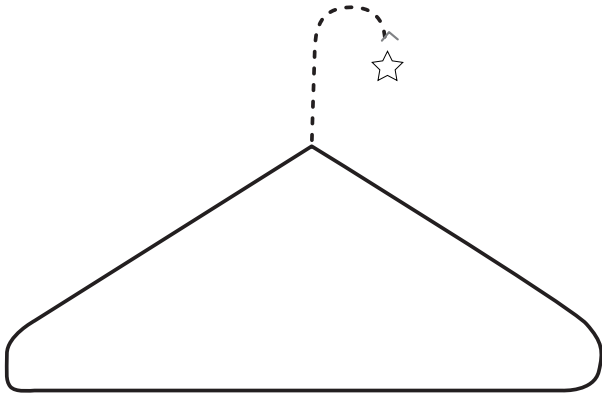
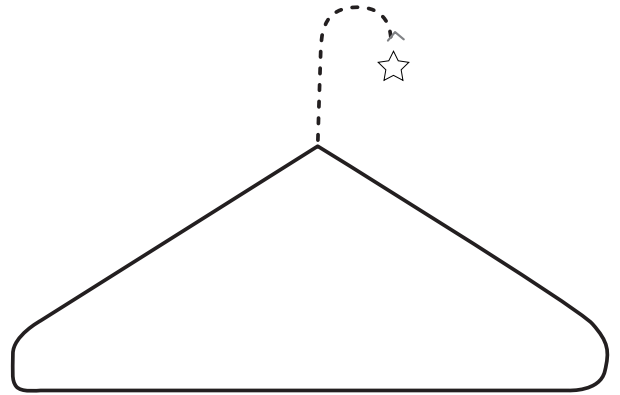
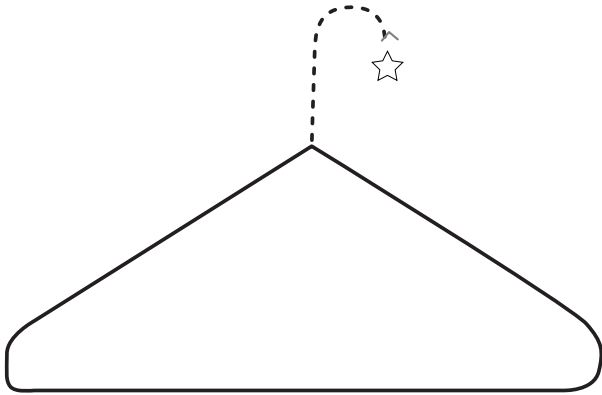

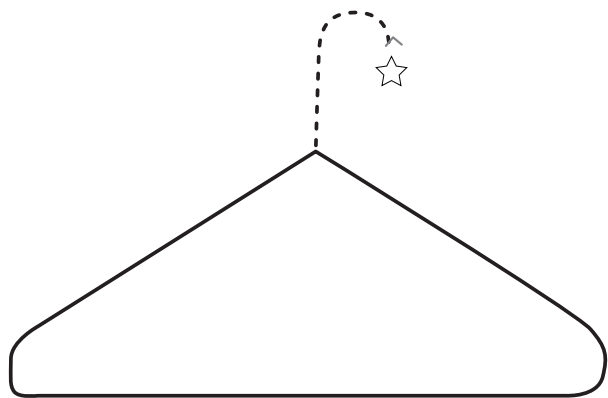
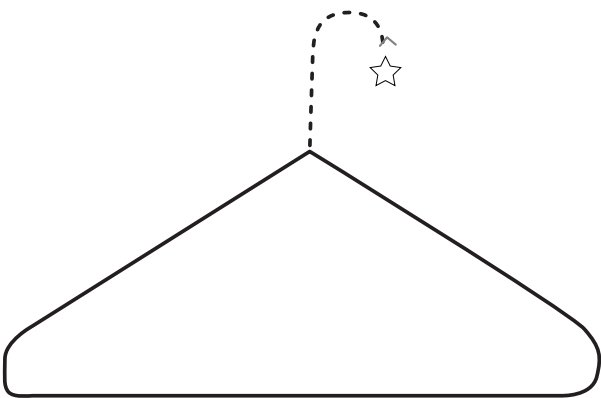
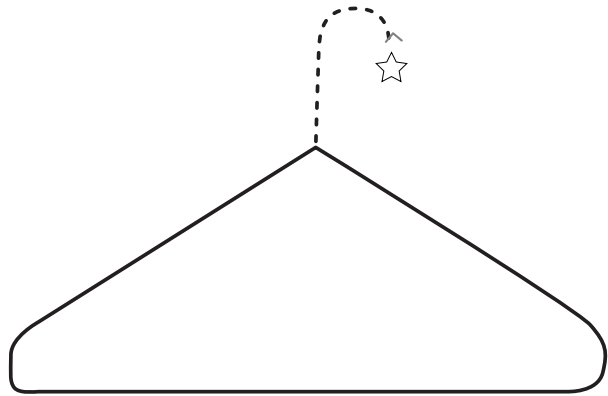
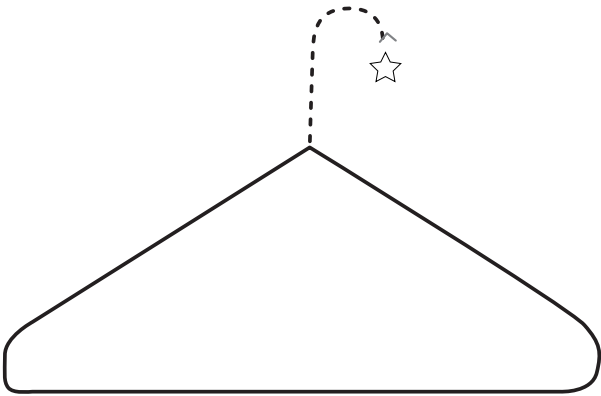
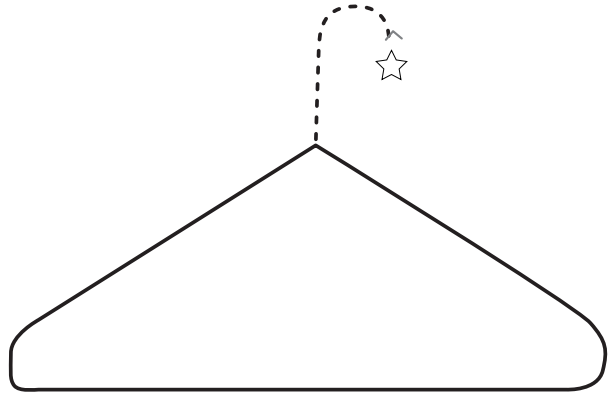
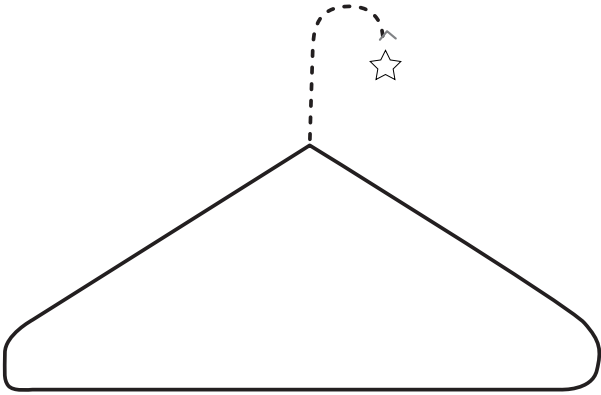

NAME: _____

DATE: _____

9.1

Activity Page

Directions: Ask students to trace the dotted hooks, starting at the stars. Students may color the pictures (optional).

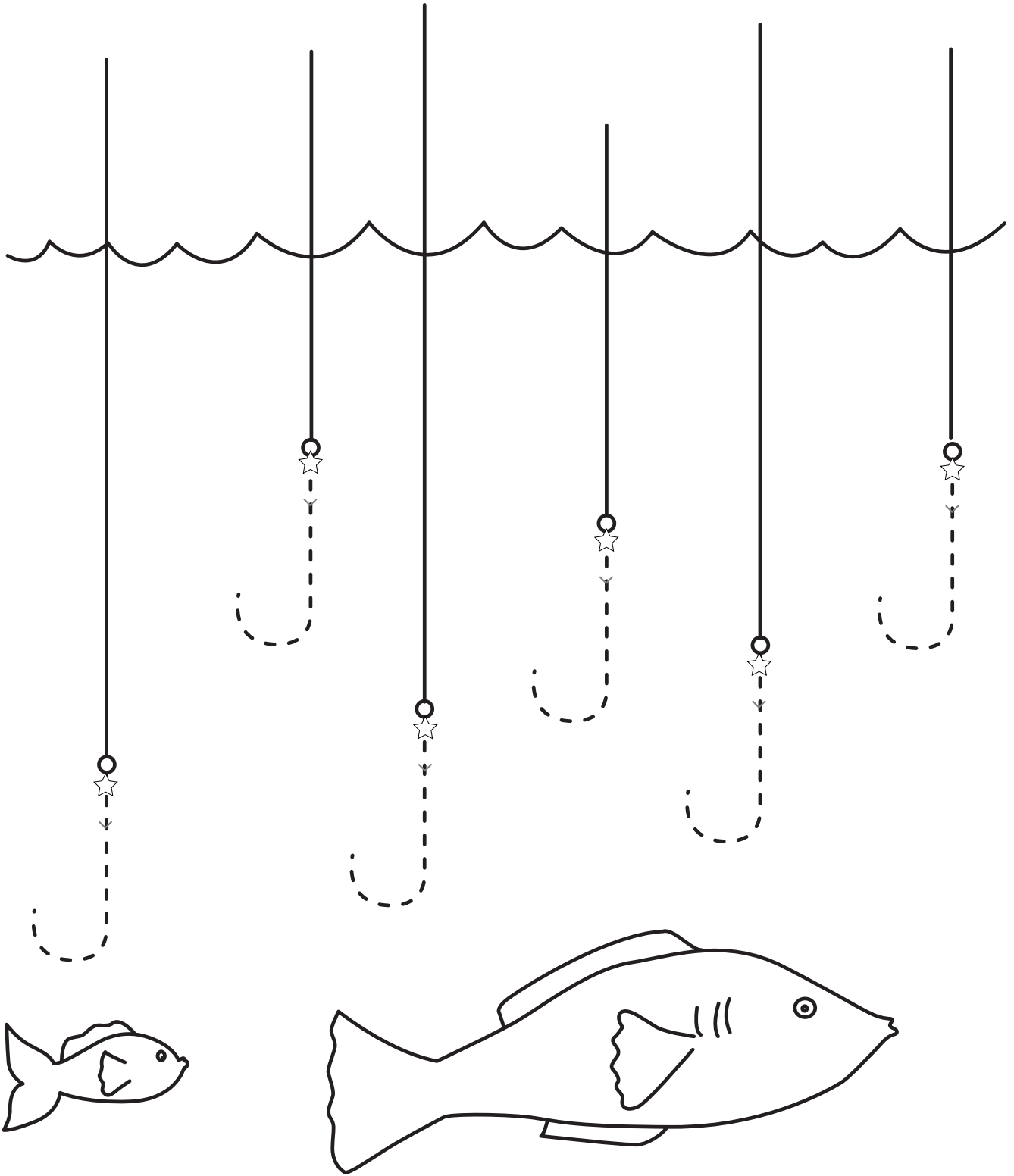

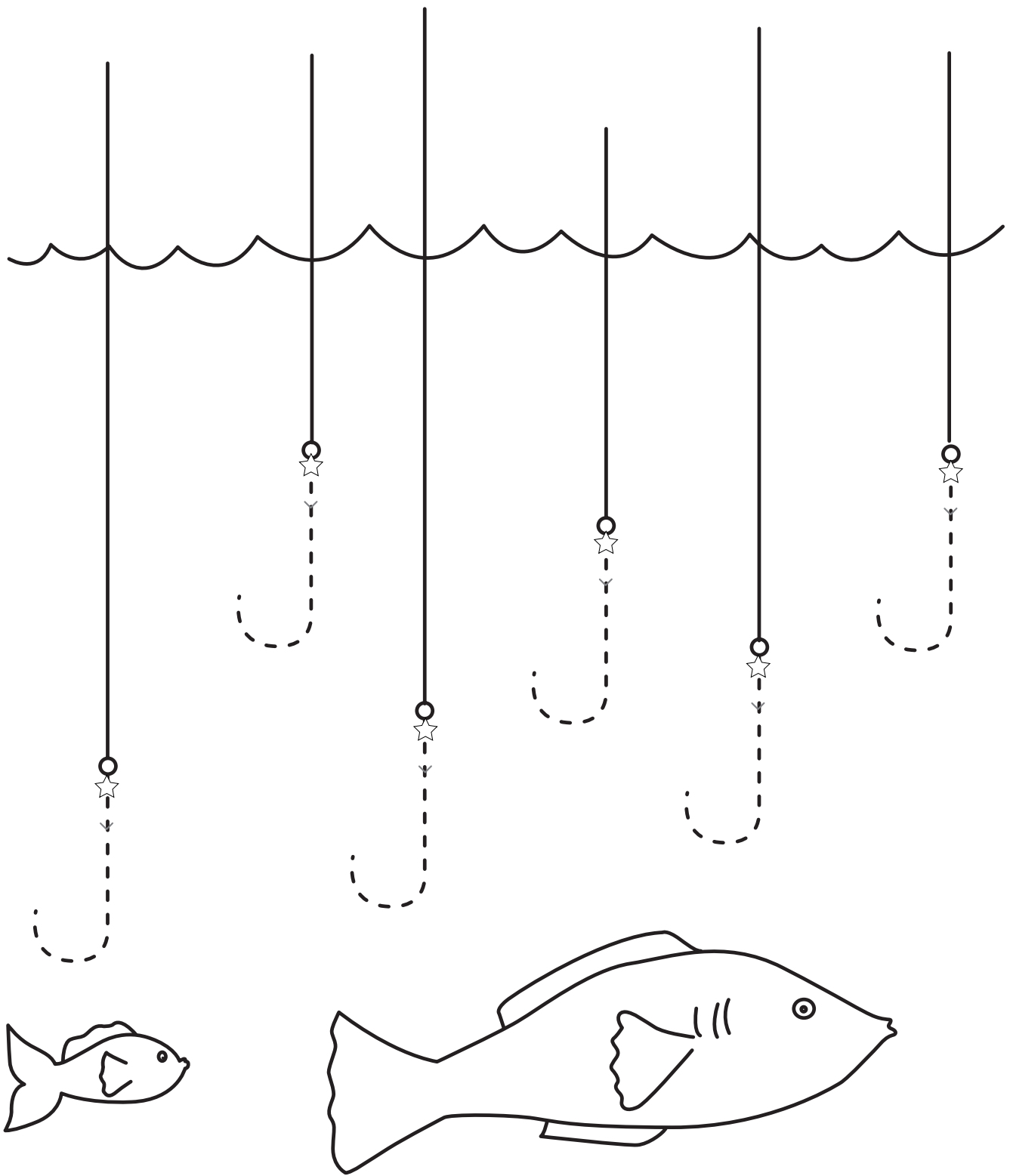

NAME: _____

DATE: _____

9.2

Take-Home

Dear Family Member,

In class, we have been practicing the hook shape. This is one of several simple shapes we are practicing for letter formation. Please have your child trace the dotted hooks on the front and back of this activity page, starting at the stars.

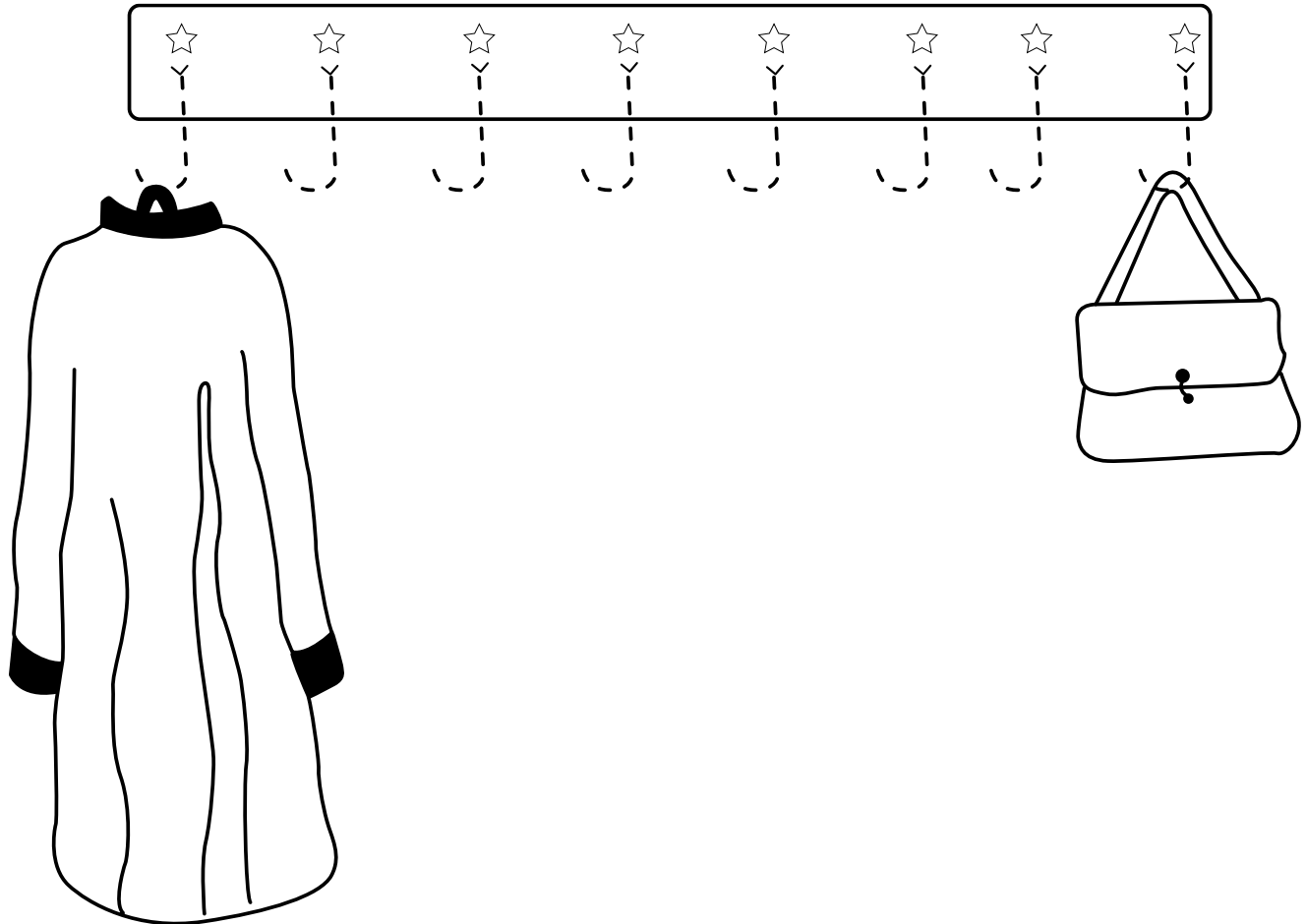

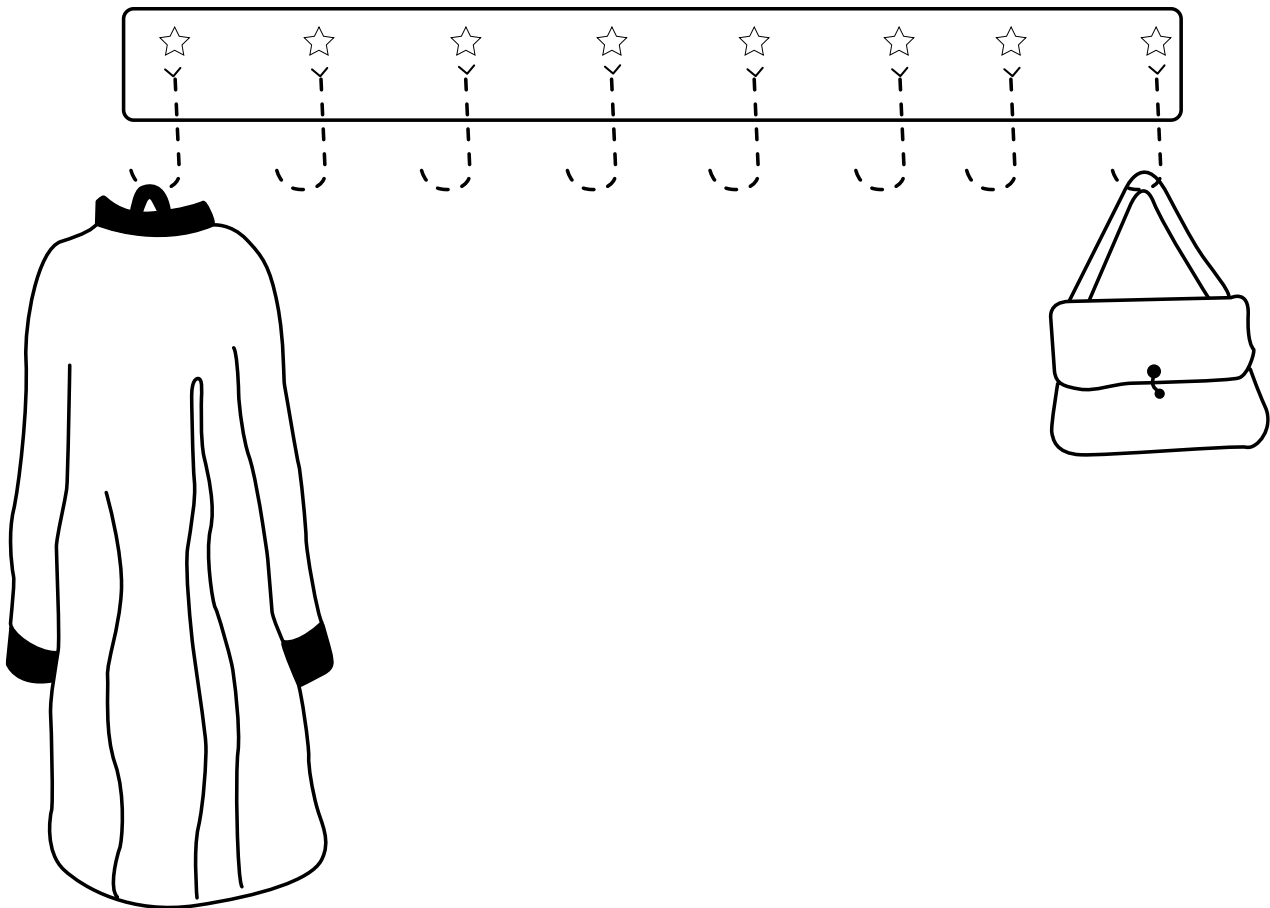
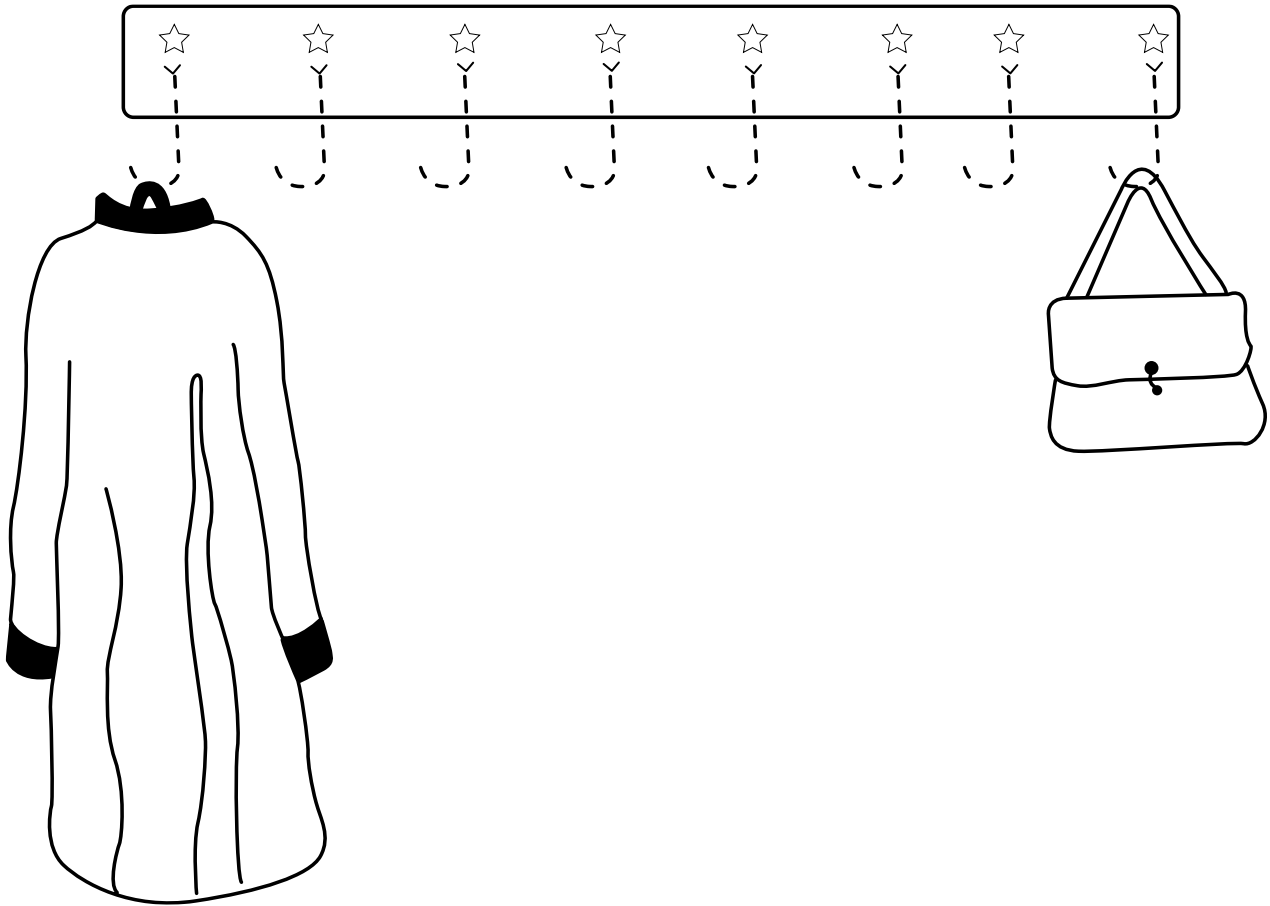

NAME: _____



DATE: _____

10.1

PART 1

Assessment

Directions: Ask students to copy each shape.

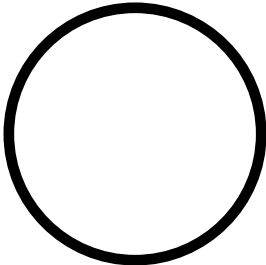

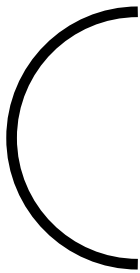
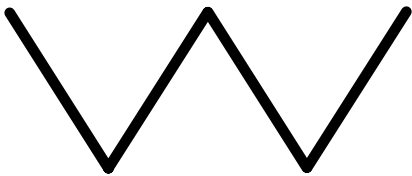
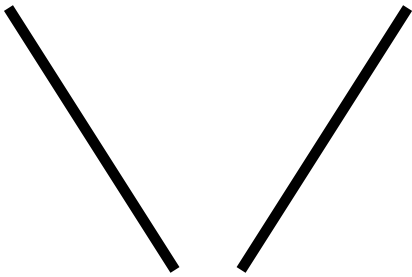
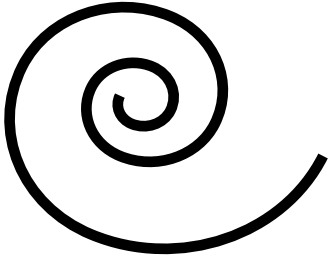
NAME: _____

DATE: _____

10.2
PART 1

Assessment

Directions: Ask students to copy each shape.

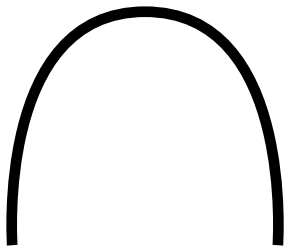
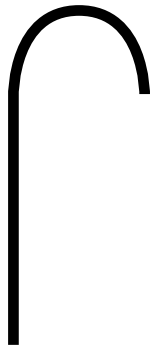
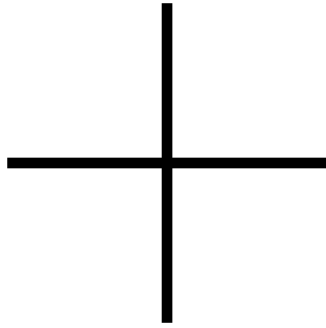

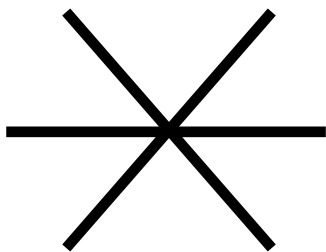
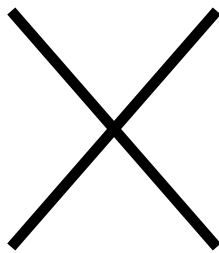
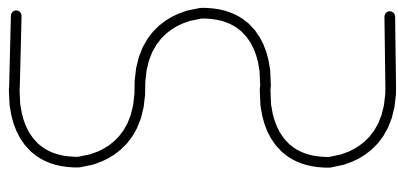
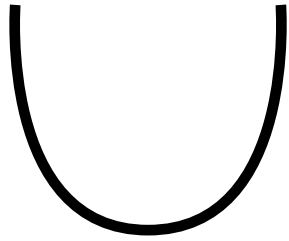

NAME: _____

DATE: _____

10.3

PART 2

Assessment

Directions: Orally segment each word and have students circle each picture.

1.



2.

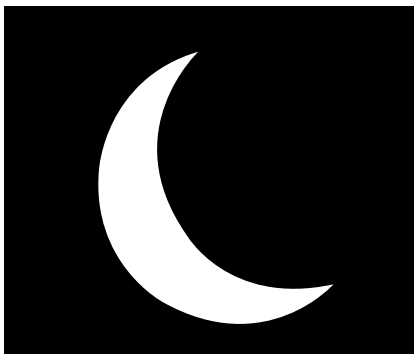

3.



4.



Part 2, Blending Score: _____

5.



6.



7.



8.



9.



10



NAME: _____

DATE: _____

10.4

Take-Home

Dear Family Member,

In class, we have been using the terms “beginning” and “end.” Knowing these terms is important for tracking from the beginning of a row to the end of a row when reading. For each row, please have your child color the shape at the *beginning* green and the shape at the *end* red, saying the word *beginning* or *end* as they color each of them.

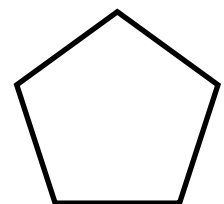
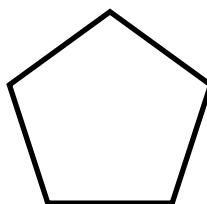
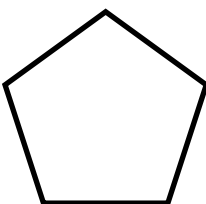
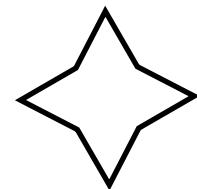
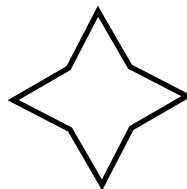
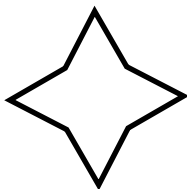
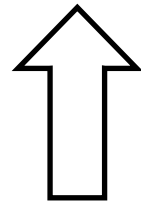
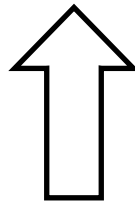
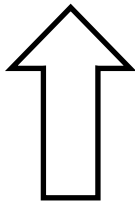
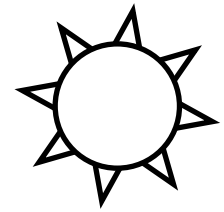
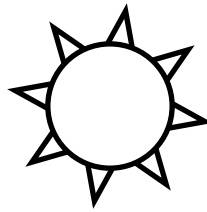
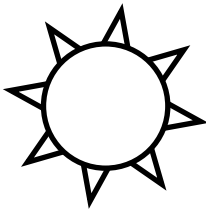

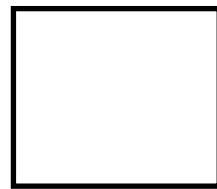
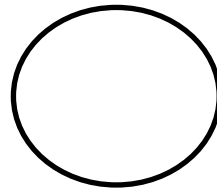
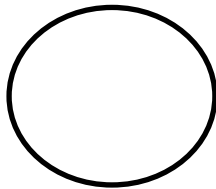
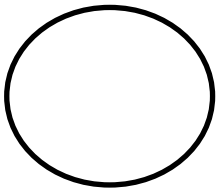
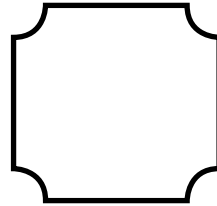
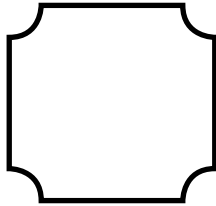
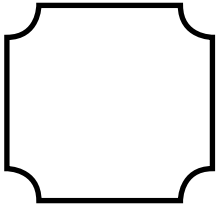
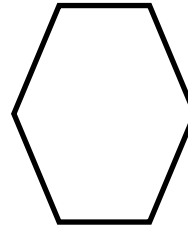
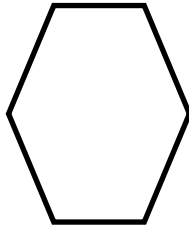
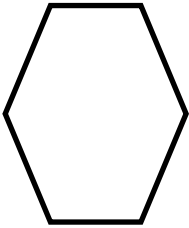
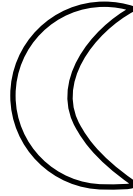
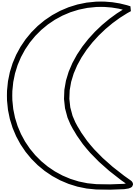
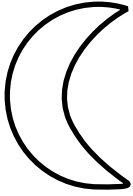











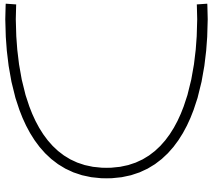



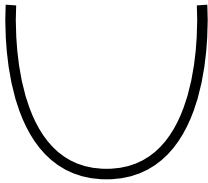



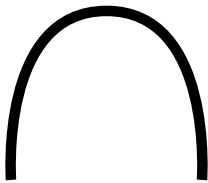



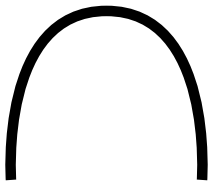

NAME: _____











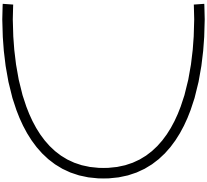



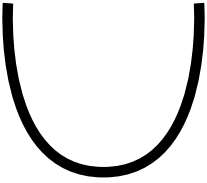



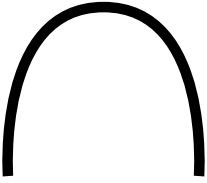



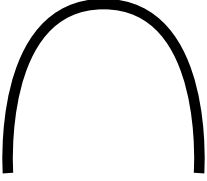

DATE: _____

PP.1

Activity Page

Directions: Ask students to first trace and then draw each shape.







NAME: _____





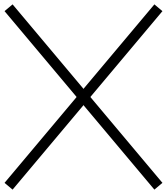
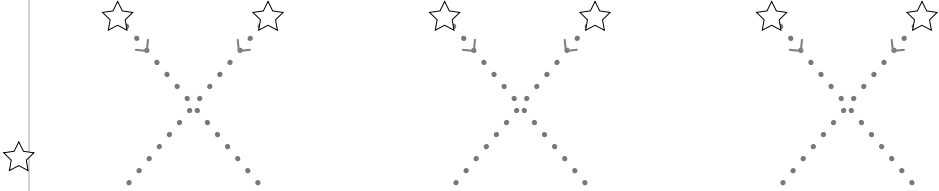

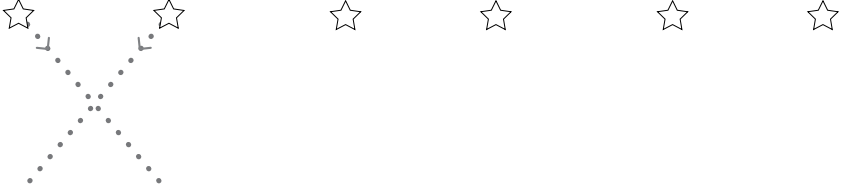
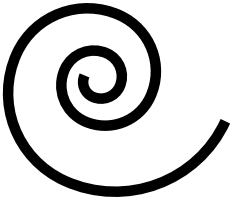
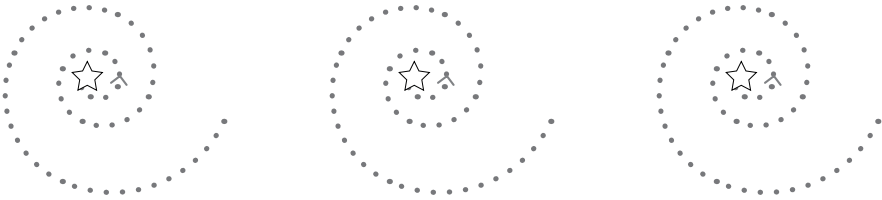
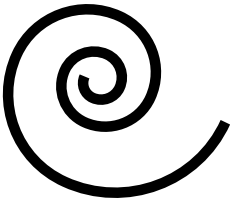
DATE: _____

PP.2

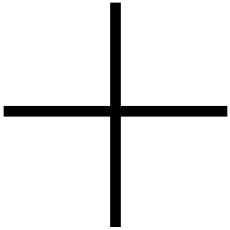
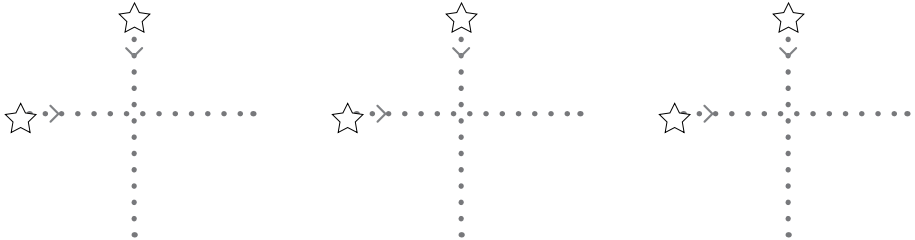
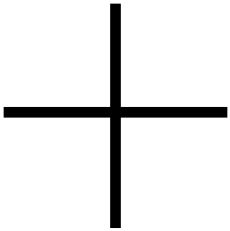
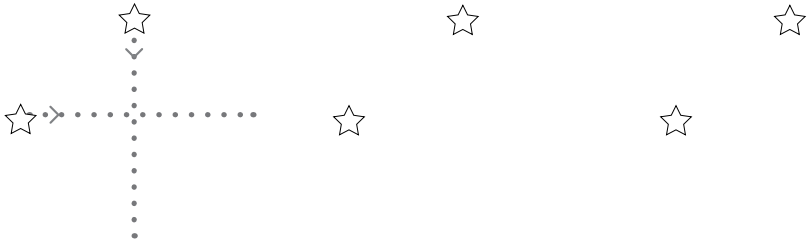
Activity Page

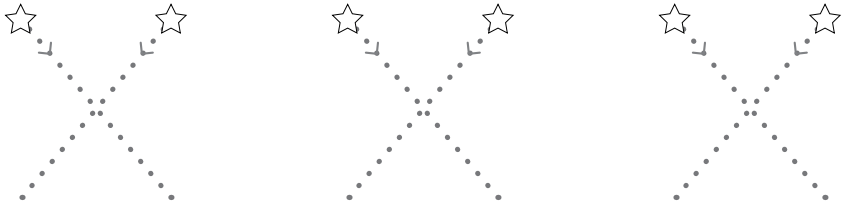
Directions: Ask students to first trace and then draw each shape

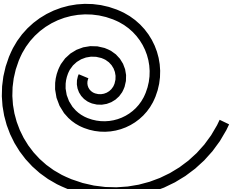
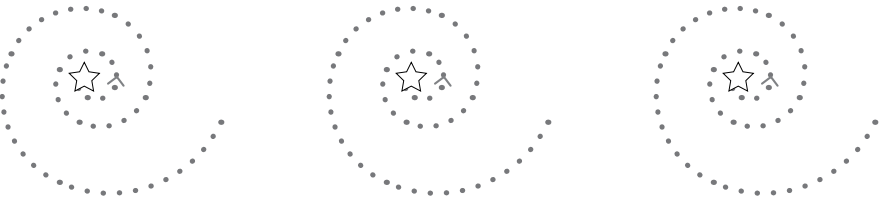
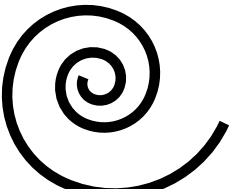









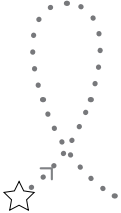
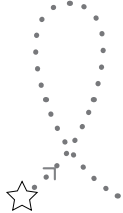
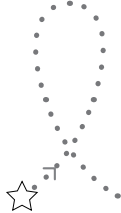

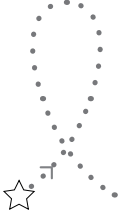







NAME: _____











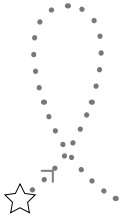
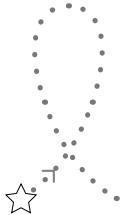
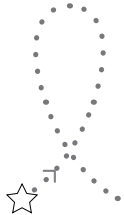

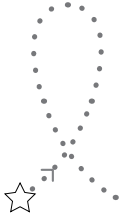







DATE: _____

PP.3

Activity Page

Directions: Ask students to first trace and then draw each shape.

























NAME: _____

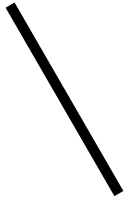









DATE: _____

PP.4

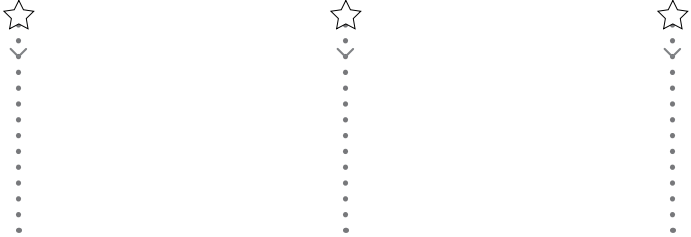
Activity Page

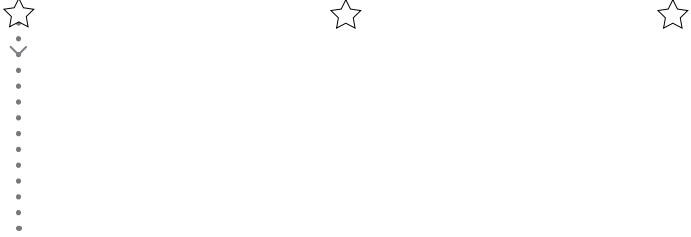
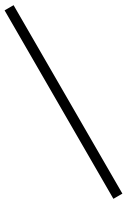
Directions: Ask students to first trace and then draw each shape.











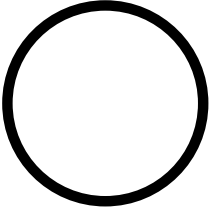



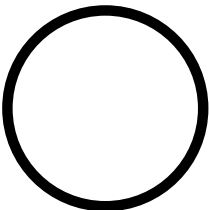
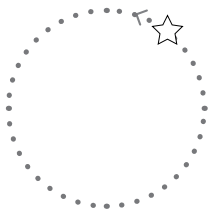

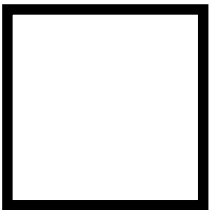
NAME: _____



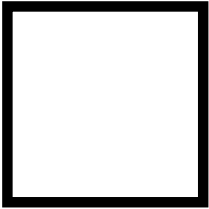



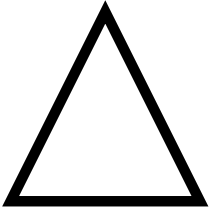
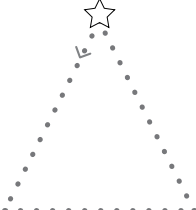
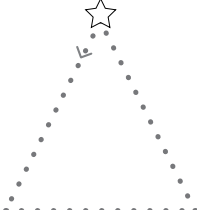
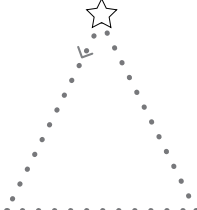
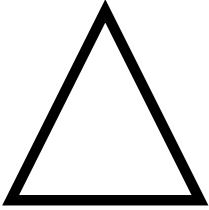
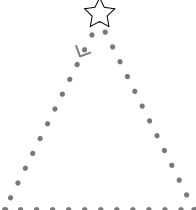

DATE: _____

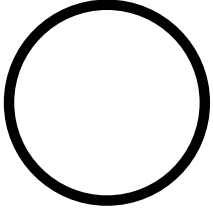
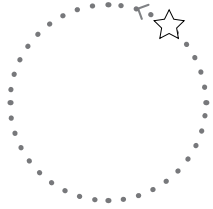
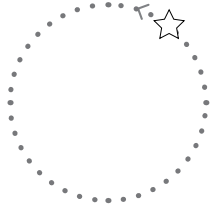
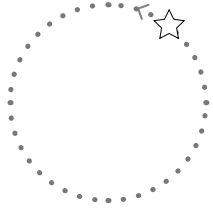
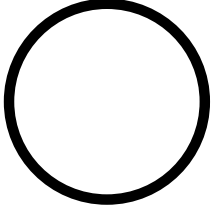
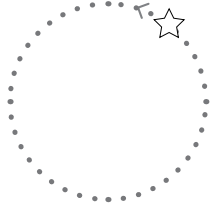
PP.5

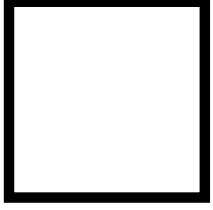
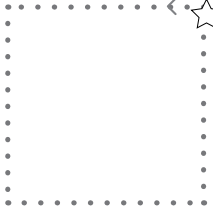
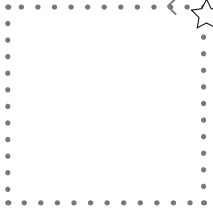
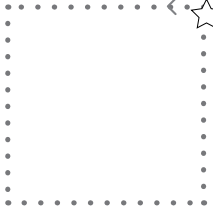
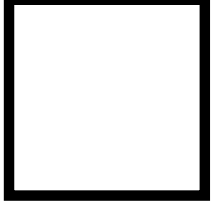
Activity Page

Directions: Ask students to first trace and then draw each shape.

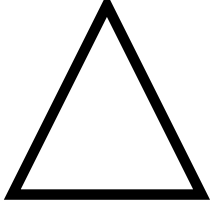
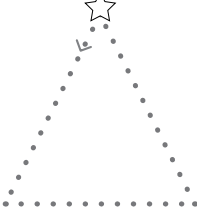
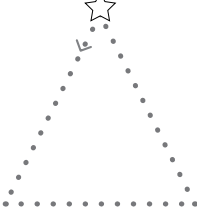
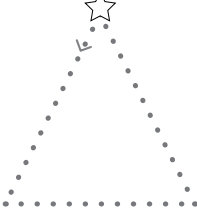
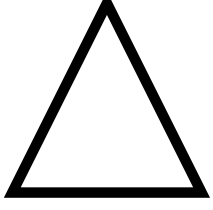
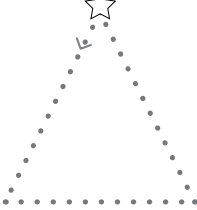

NAME: _____

DATE: _____

PP.6

Directions: Using different colors, have students decorate the interior of the shape using a combination of writing strokes.

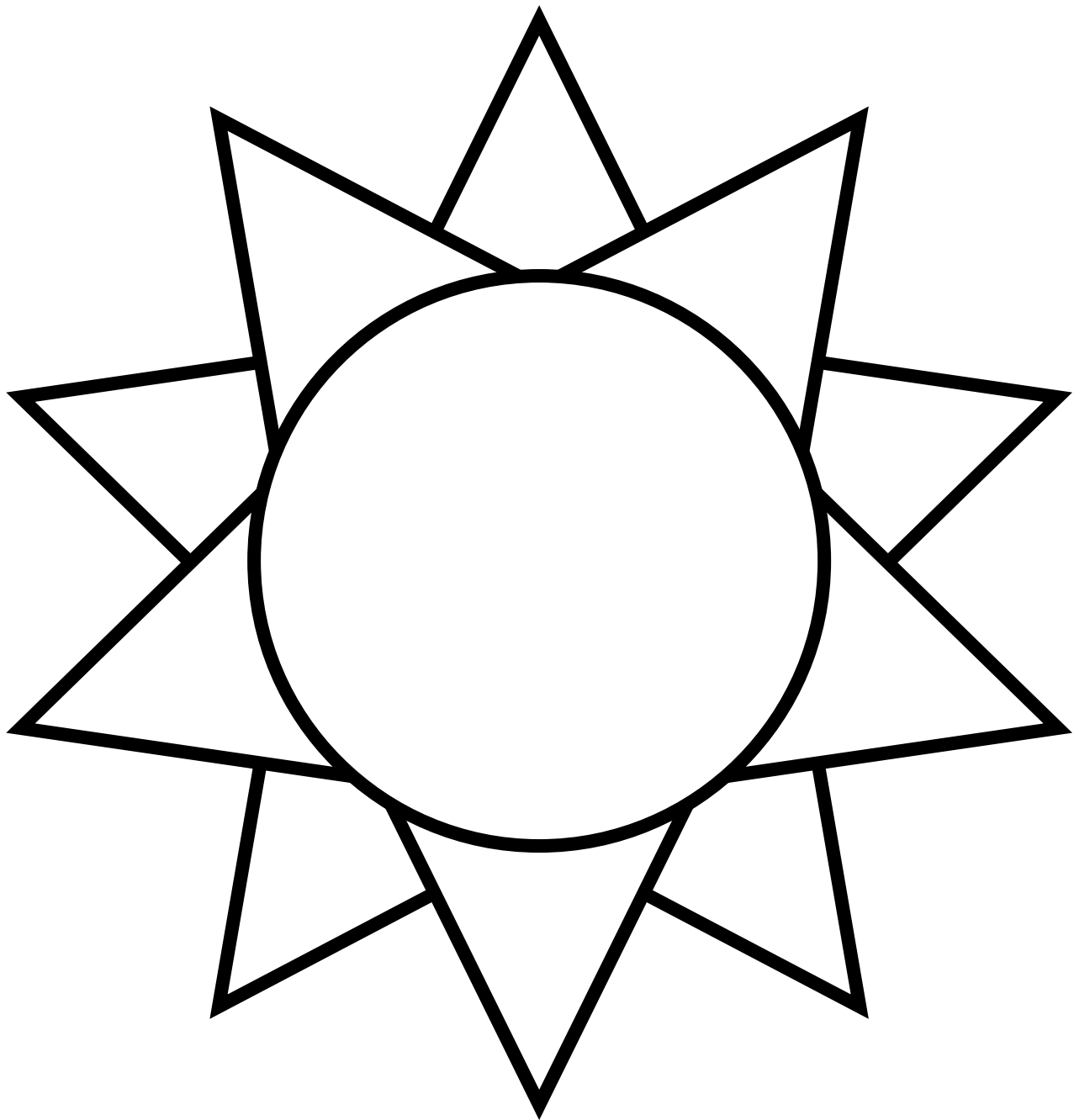

NAME: _____

DATE: _____

PP.7

Activity Page

Directions: Using different colors, have students decorate the interior of the shape using a combination of writing strokes.

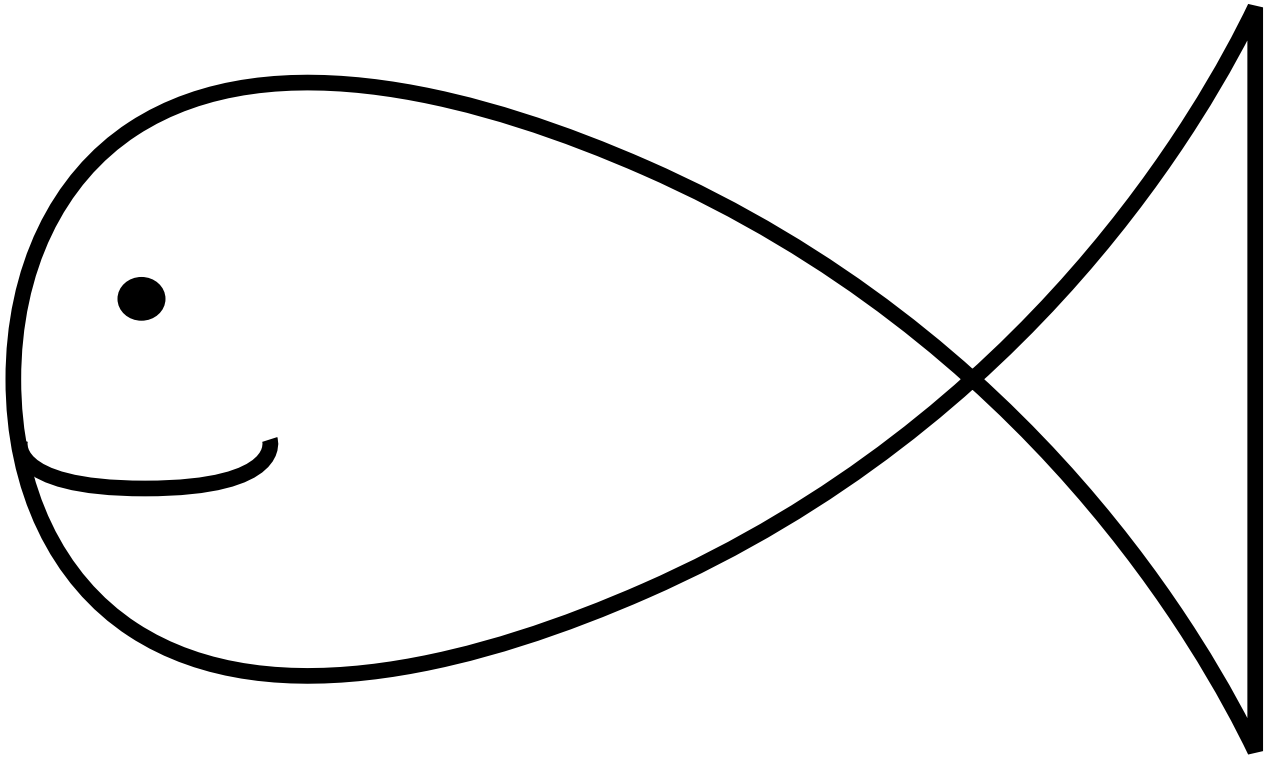

NAME: _____

DATE: _____

PP.8

Activity Page

Directions: Using different colors, have students decorate the interior of the shape using a combination of writing strokes.

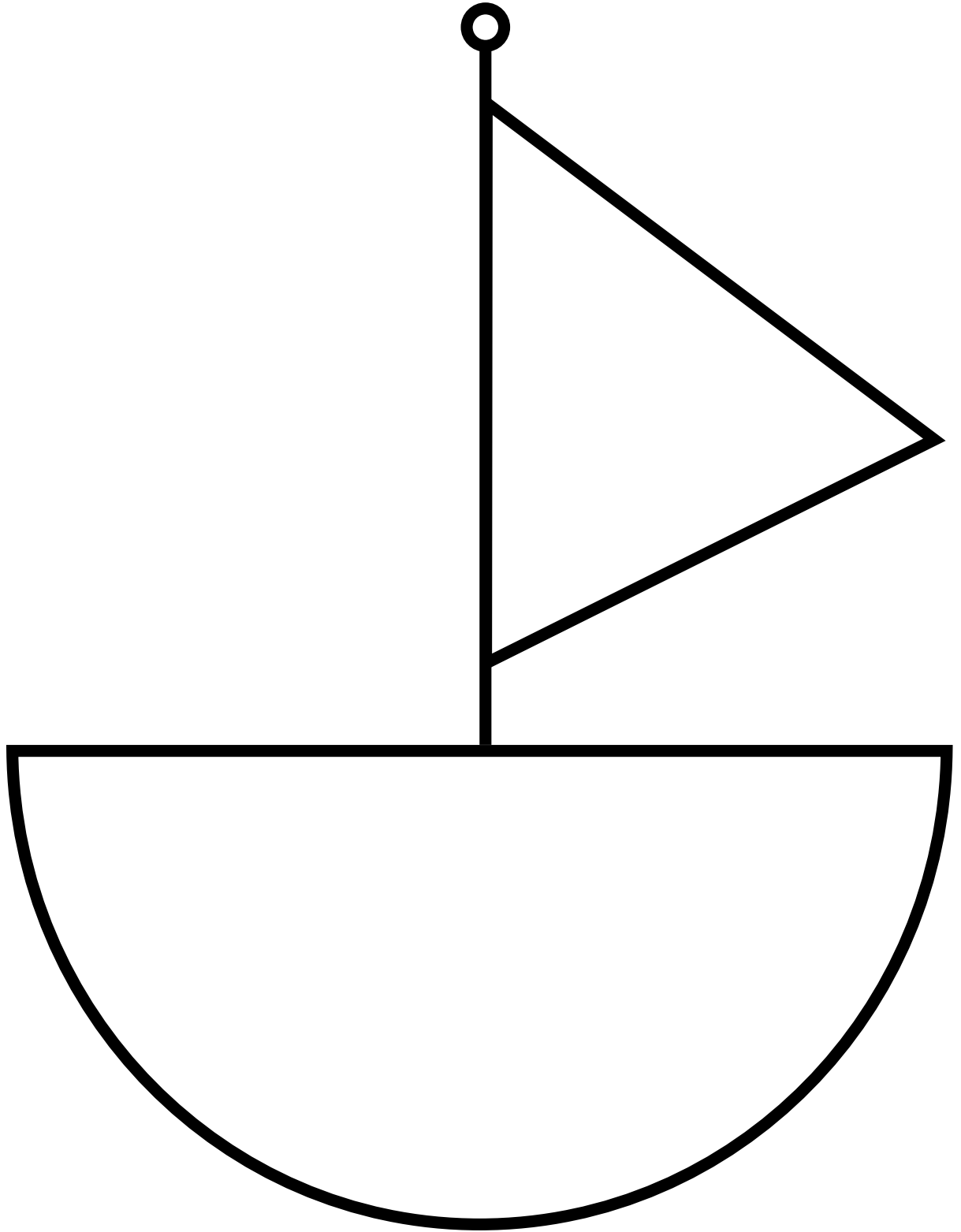

NAME: _____

DATE: _____

PP.9



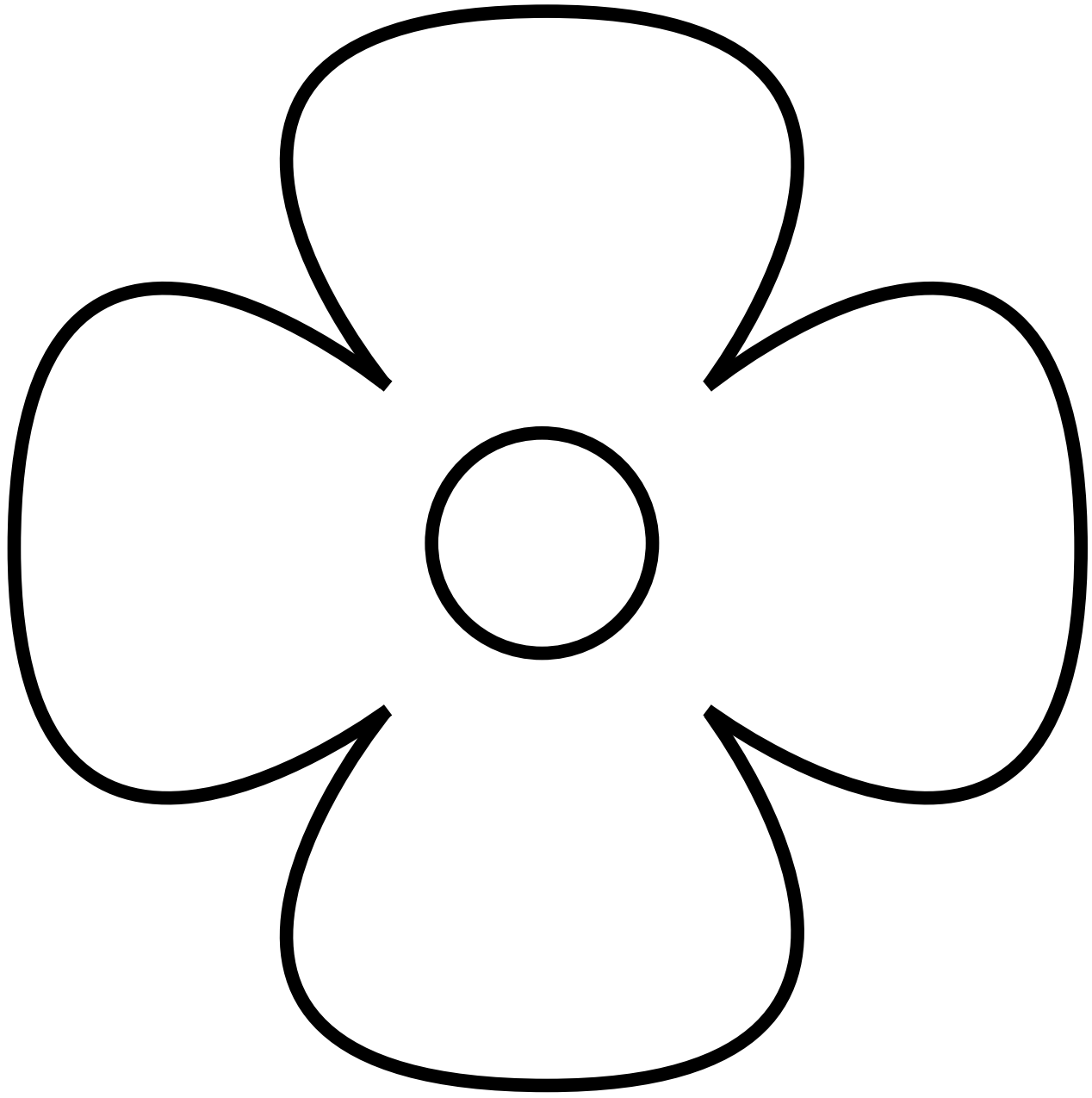



Directions: Using different colors, have students decorate the interior of the shape using a combination of writing strokes.

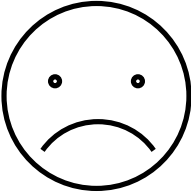
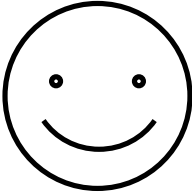
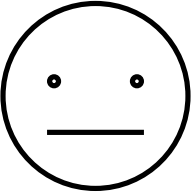
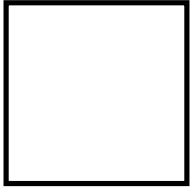
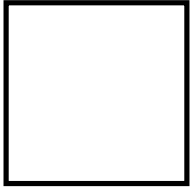
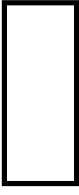

NAME: _____

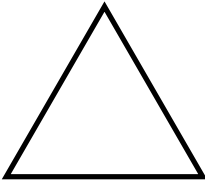
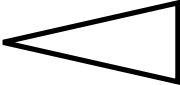
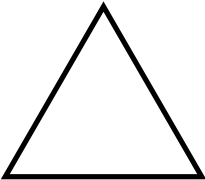
DATE: _____

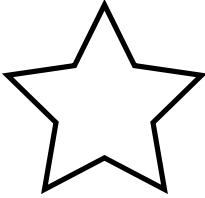
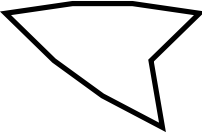
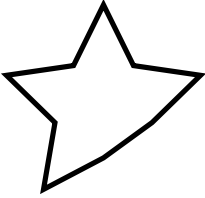
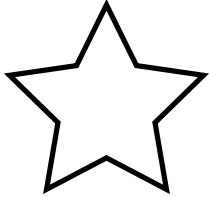
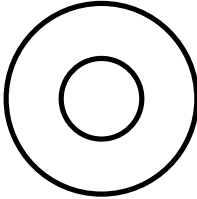
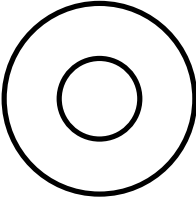
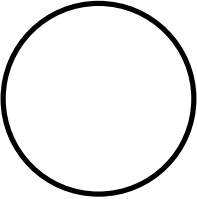
Directions: For each row, have students circle the shape that is the same as the shape on the left and cross out the shapes that are different.

NAME: _____

DATE: _____

PP.11

Directions: For each row, have students circle the shape that is the same as the shape on the left and cross out the shape that is different.

t	f	t
i	j	i
w	w	v
o	a	o
d	d	b
e	e	c

n	n	m
x	t	x
u	n	u
g	g	a
h	n	h
f	t	f

NAME: _____

DATE: _____

Directions: For each row, have students color the shape that is at the beginning green, the shape that is at the middle yellow, and the shape that is at the end red.

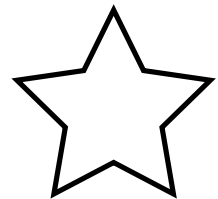
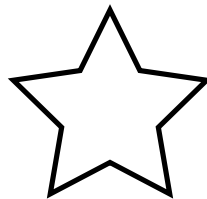
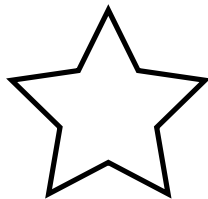
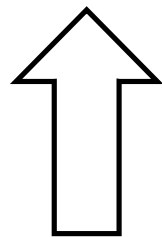
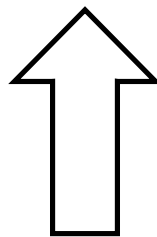
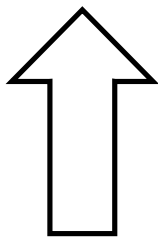
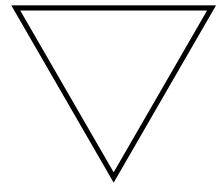
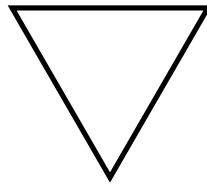
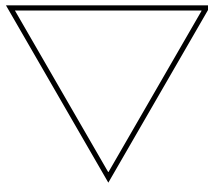
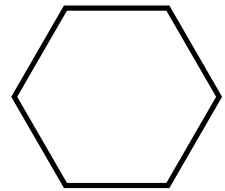
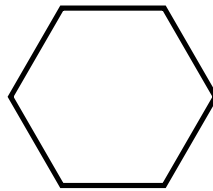
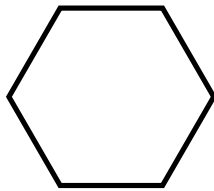
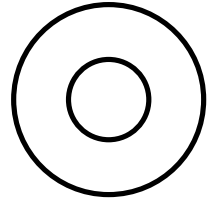
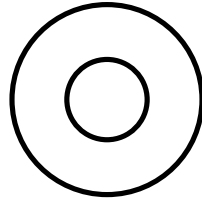
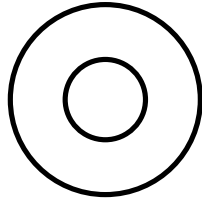

Credits

Every effort has been taken to trace and acknowledge copyrights. The editors tender their apologies for any accidental infringement where copyright has proved untraceable. They would be pleased to insert the appropriate acknowledgment in any subsequent edition of this publication. Trademarks and trade names are shown in this publication for illustrative purposes only and are the property of their respective owners. The references to trademarks and trade names given herein do not affect their validity.

All photographs are used under license from Shutterstock, Inc. unless otherwise noted.

Illustrators and Image Sources

1.1: Staff; 1.2: Staff; 1.3: Staff; 2.1: Staff; 2.2: Staff; 3.1: Staff; 3.2: Staff; 3.3: Staff; 4.1: Staff; 4.2: Staff; 4.3: Staff; 5.1: Staff; 5.2: Staff; 6.1: Staff; 6.2: Staff; 7.1: Staff; 7.2: Staff; 8.1: Staff; 8.2: Staff; 9.1: Staff; 9.2: Staff; 10.1: Staff; 10.2: Staff; 10.3: Shutterstock, Staff; 10.4: Staff; PP.1: Staff; PP.2: Staff; PP.3: Staff; PP.4: Staff; PP.5: Staff; PP.6: Staff; PP.7: Staff; PP.8: Staff; PP.9: Staff; PP.10: Staff; PP.12: Staff

Regarding the Shutterstock items listed above, please note: "No person or entity shall falsely represent, expressly or by way of reasonable implication, that the content herein was created by that person or entity, or any person other than the copyright holder(s) of that content.



Kindergarten | Skills 2 | Activity Book

ISBN 9798891808867



9 798891 808867